

United States
Department of
Agriculture

Natural
Resources
Conservation
Service

Part 628 Dams National Engineering Handbook

Chapter 45

Filter Diaphragms

Issued January 2007

The U.S. Department of Agriculture (USDA) prohibits discrimination in all its programs and activities on the basis of race, color, national origin, age, disability, and where applicable, sex, marital status, familial status, parental status, religion, sexual orientation, genetic information, political beliefs, reprisal, or because all or a part of an individual's income is derived from any public assistance program. (Not all prohibited bases apply to all programs.) Persons with disabilities who require alternative means for communication of program information (Braille, large print, audiotape, etc.) should contact USDA's TARGET Center at (202) 720-2600 (voice and TDD). To file a complaint of discrimination, write to USDA, Director, Office of Civil Rights, 1400 Independence Avenue, SW., Washington, DC 20250-9410, or call (800) 795-3272 (voice) or (202) 720-6382 (TDD). USDA is an equal opportunity provider and employer.

Acknowledgments

This document was developed by Danny K. McCook, Geotechnical Engineer, NDCSM Center, NRCS, Fort Worth, Texas. The examples in appendix C were originally developed by William Hughey, retired. The examples were formerly contained in SNTC Technical Note 709.

Special recognition is given to **Wade Anderson**, engineer, NRCS, Fort Worth, Texas, and **Benjamin Doerge**, engineer, NRCS, Fort Worth, Texas, for their many helpful comments during the review.

Special thanks to the technical publications team: **Lynn Owens**, editor; **Wendy Pierce**, illustrator; and **Suzi Self**, editorial assistant.

Preface

This document contains criteria and guidance formerly included in TR-60 and SNTC Technical Note 709. This material supersedes and replaces the guidance on filter diaphragms contained in those documents.

Chapter 45

Filter Diaphragms

Contents	628.4500	Background	45-1
	628.4501	Anti-seep collars	45-2
	628.4502	Hydraulic fracture	45-4
	628.4503	Filter diaphragm	45-6
		(a) Introduction	45-6
		(b) Design of filter diaphragm.....	45-6
		(c) Dimensions of filter diaphragms	45-7
		(d) Filter and drain gradation	45-7
	628.4504	Specifications and density quality control for filter sands	45-8
		(a) Method placement specification	45-9
		(b) Performance specification	45-10
	628.4505	Quality control	45-10
		(a) Method specifications.....	45-10
		(b) Performance specifications.....	45-10
	628.4506	Installation of filter diaphragms	45-11
		(a) Methods of construction	45-11
	628.4507	References	45-18
Appendices			
	A	Dimensions and Location of Filter Diaphragms in Embankments	
	B	Supplemental Tests for Filters	
	C	Examples for Sizing Filter Diaphragms	
Tables	Table 45A-1	Typical values of settlement ratio—positive projecting conduits	45A-5

Figures		
Figure 45-1	Failed embankments	45-3
Figure 45-2	Arching in earthfill	45-5
Figure 45-3	Effect of placement water content on vibrated density	45-8
Figure 45-4	Small vibratory compaction equipment	45-9
Figure 45-5	Cut and fill method	45-13
Figure 45-6	Concurrent method	45-14
Figure 45-7	Filter diaphragm construction	45-16
Figure 45A-1	Requirements for the horizontal extent of the filter diaphragm for rigid circular conduits	45A-2
Figure 45A-2	Requirements for the horizontal extent of a filter diaphragm for rectangular box conduits	45A-2
Figure 45A-3	Additional notation that the filter diaphragm need not extend more than 5 feet horizontally past the slopes of any excavation made to install the conduit	45A-3
Figure 45A-4	Requirement that the diaphragm extend vertically above the conduit a dimension equal to 3 times the diameter of circular conduits or 3 times the height of a box conduit	45A-3
Figure 45A-5	Exception to the requirement that the diaphragm extend vertically a dimension equal to 3 times the diameter of the conduit	45A-4
Figure 45A-6	Requirement for downward extent of filter diaphragm settlement ratio equal to 0.7 or more	45A-5
Figure 45A-7	Required lower extent of filter diaphragm for settlement ratios of 0.7 or greater when trench is excavated to install conduit	45A-6
Figure 45A-8	Required downward limits of filter diaphragm when bedrock is encountered above otherwise recommended depths	45A-7
Figure 45A-9	Guidelines for conduits on foundations with settlement ratios of less than 0.7 where no trench is excavated to install conduit and bedrock is not encountered	45A-7
Figure 45A-10	Minimum extent of filter diaphragm for flexible conduits	45A-8

Figure 45A-11	Minimum thickness requirement for large and moderate to high hazard embankments, small, low hazard dams may use a 2.0 ft minimum thickness	45A-9
Figure 45A-12	Minimum dimensions of zones in a two-stage filter diaphragm	45A-10
Figure 45A-13	Downstream of the cutoff trench	45A-11
Figure 45A-14	Downstream of the centerline of the dam when no cutoff trench is used	45A-11
Figure 45A-15	Upstream face of the diaphragm in relation to the downstream face of the dam	45A-12
Figure 45A-16	Zoned embankments	45A-12
Figure 45A-17	Zoned embankments	45A-13
Figure 45B-1	Importance of self-healing properties in filter diaphragms	45B-1
Figure 45B-2	Vaughan and Soares test for self-healing characteristics	45B-2
Figure 45B-3	Vaughan and Soares test on sample with poor self-healing characteristics	45B-2
Figure 45B-4	Vaughan and Soares test on sample with good self-healing characteristics	45B-3
Figure 45B-5	Compressive strength specimen	45B-3
Figure 45C-1	Embankment cross section for example 1	45C-2
Figure 45C-2	Filter diaphragm for example 1	45C-3
Figure 45C-3	Profile of drain for example 1	45C-4
Figure 45C-4	Two-stage drain	45C-5
Figure 45C-5	Structure layout and phreatic line computation	45C-7
Figure 45C-6	Filter diaphragm for example 2	45C-8
Figure 45C-7	Filter diaphragm to the downstream toe	45C-9

628.4500 Background

Embankment failures and accidents occur more often in the vicinity of conduits in the embankments than at other locations. These accidents and failures associated with conduits in embankments are of several types:

- Defects in the walls of the conduit may develop over time. Seepage water from the reservoir may percolate through soils with low piping resistance and carry fines into any defects in non-pressurized conduits. In pressurized conduits, the water may escape the conduit and erode soils surrounding the defects. In either case, the surrounding earthfill next to the conduit is damaged, and sinkholes or other problems can develop. Corrugated metal pipe (CMP) is most susceptible to this problem.
- Joints may separate from several causes. Conduits on soft foundations may spread and separate under the loading of the dam if the design does not adequately consider this potential. Joint gaskets may be improperly installed, and bands on corrugated metal pipe may be inadequate. In either case, the surrounding earthfill may erode at the separated joint.
- Water may flow along the contact between the conduit and surrounding soils and erode the soils, leading to partial or full discharge of the reservoir water through the openings. In the case of highly erodible soils, the occurrence may lead to a breaching type failure.
- Water may flow through hydraulic fracture cracks in the earthfill above and to either side of the conduit. Conduits often create differential settlement that is conducive to hydraulic fracture, as discussed later in this chapter.

Guidance on topics related to design of conduits is available in other references. To prevent defects from occurring in the walls of the conduit, materials must be selected that have a design life suitable for the structure being designed. Corrugated metal pipes that do not have adequate corrosion protection are especially susceptible to developing defects in the walls of the conduit. Designing conduits to prevent separation of joints is also covered in other references. This chap-

ter concentrates on problems related to water flowing externally in soils surrounding the conduit.

Water flowing along the contact between conduits and surrounding soil is often attributed to poorly compacted soil next to the conduit. Compacting soils uniformly near conduits is difficult for several reasons. First, hand-held equipment must be used next to the conduit because large equipment cannot be used near conduits to prevent damaging them. The zones of hand-compacted soil next to conduits have different properties than the soils that are compacted with large equipment. Secondly, compacting soils under the haunches of circular pipes that do not rest on a cradle or bedding is difficult. Even hand-held compactors cannot direct their energy uniformly under the haunches of pipes. If too much energy is used to compact soils under the haunches of conduits, the conduit may be lifted, creating voids under the pipe.

These problems are most common where flexible conduits constructed of plastic or corrugated metal are used because they rarely are installed on bedding or cradles. Flexible conduits are not placed on cradles or bedding because these would limit their deflection, and the deflection is important to develop the design strength of these types of conduits.

The other type of problem often associated with conduits occurs when water flows through cracks in the earthfill above and to either side of the conduits. Cracks in earthfills are often associated with conduits because the conduits can cause differential settlement of the earthfill. The soil columns on both sides of a conduit compress more than the soil column over a conduit. This differential settlement can result in cracking of the embankment under some conditions.

Differential settlement may also be associated with trenches that are sometimes used to install conduits. A trench condition can create differential settlement when the compacted soil backfill in the trench has very different properties than the foundation soils in the sides of the trench. This problem is most serious for soft or collapsible foundation soils and for trenches with overly steep side slopes. Side slopes of 3H:1V or flatter are usually specified for trenches transverse to an embankment.

Even if the embankment does not initially develop visible cracks from these differential movements, zones of low stresses may occur in the fill. Hydraulic fracturing may occur in zones of low stresses that can lead to pathways for water flow. Water may flow along hydraulic fracture cracks, as well as flowing along pre-existing cracks in the fill. Problems with hydraulic fracturing often occur when an embankment first impounds water to the full pool depth after construction. Hydraulic fracture is discussed in detail later in this chapter.

For all these reasons, the potential for water to flow directly along the outside of conduits and through cracks in the earthfill surrounding a conduit is a serious problem that must be addressed by suitable design measures. Two design measures have commonly been used to address the concern about water flow through the earthfill surrounding conduits. They are:

- anti-seep collars
- filter diaphragms

628.4501 Anti-seep collars

For many years, anti-seep collars were the standard design approach used to block the flow of water at the interface of the conduit and the backfill surrounding the conduit for all embankments designed by most design agencies. Based on knowledge gained during the period of intensive embankment construction by NRCS and other agencies in the 1960s through 1980s, the use of anti-seep collars was reconsidered. Beginning in the mid-1980s, anti-seep collars were eliminated in designs of major embankment projects because they were judged to be ineffective in preventing many types of failures observed. All of the major embankment design agencies, such as the U.S. Army Corps of Engineers (USACE), Bureau of Reclamation, and NRCS, as well as private consultants, now specify filter diaphragms rather than anti-seep collars. Filter diaphragms have been recognized as superior to anti-seep collars as a seepage control measure. The NRCS still allows the use of anti-seep collars for seepage control along conduits for low hazard dams that are built according to criteria in Conservation Practice Standard (CPS) 378. Filter diaphragms are required design elements in embankments that are outside of CPS 378.

Anti-seep collars originally had two basic purposes. One was to prevent flow along the interface between the conduit and the compacted backfill; the other was to increase the length of the flow path for the seepage water. By forcing water to flow a greater distance, the theory was that more hydraulic head is dissipated. This reduces the energy of the water where it exits the embankment and foundation at the downstream toe of the dam. The theory of increasing the length of the flow path to decrease the potential for piping was based on experience with concrete gravity dams.

Anti-seep collars are typically constructed of metal, concrete, or plastic. Often, the same material is used for the collars as used for the conduit. The CPS for smaller embankments, CPS 378, as amended, requires filter diaphragms to be used for problematic soil types. The NRCS criteria for larger embankments are contained in TR-60, which was revised in October 1985 to require that anti-seep collars no longer be used as a design measure. This amendment required that filter diaphragms be substituted for anti-seep collars in the design of all structures governed by TR-60. Filter dia-

phragms are discussed in detail in following sections. Anti-seep collars were discontinued on TR-60 size embankments because:

- Several NRCS embankments constructed in the 1960s and 1970s failed the first time the reservoirs filled following construction. The embankments that failed had anti-seep collars that were properly designed and installed, and the surrounding backfill was adequately compacted. It was obvious that the failures were not prevented by the collars. Most of the failures occurred in dams constructed of dispersive clays. Figure 45-1 shows typical embankments that failed even though properly installed anti-seep collars were included in their designs. Failure occurred from hydraulic fracture in dispersive clay embankments. These NRCS embankments failed when the reservoir filled suddenly soon after the dams were completed. Failure was attributed to flow along hydraulic fracture cracks in the embankment. Anti-seep collars were correctly installed and good quality control was used around the anti-seep collars.
- These failures usually occurred shortly after completion of the dam, when the pool filled quickly for the first time. Obviously, not enough time had elapsed for seepage to have caused the failures. One of the purposes of anti-seep collars was to increase the length of the seepage path and, thereby, reduce the hydraulic gradient at the downstream toe. If seepage flow was not responsible for the failures, the function of the collars to increase the length of the seepage flow path was not germane to the problem.
- Studies of the failed embankments showed that the pathway for the water that eroded a tunnel through the dam was most often not directly along the contact between the conduit and backfill, but it was in the earthfill above or to either side of the conduit.
- The Soil Mechanics Laboratory in Lincoln, Nebraska, initiated a testing program on filters for soils in the 1980s. The testing demonstrated the efficacy of a sand filter in intercepting and sealing flow through cracks in an earthfill, thus, preventing subsequent erosion.

Figure 45-1 Failed embankments



In summary, the reasons anti-seep collars were replaced by filter diaphragms in TR-60 were:

- A number of dams failed even though properly designed and installed anti-seep collars were used.
- Sand filters were demonstrated to be successful in controlling erosion by water flowing through cracks in earthfill in laboratory experiments conducted by the NRCS.

Factors that contributed to the failures of the NRCS earthfills are discussed in following sections. The discussion should provide better understanding of the reasons filter diaphragms have become the accepted method for preventing uncontrolled flow of water in earthfill surrounding conduits.

628.4502 Hydraulic fracture

Cracks in earth dams have many causes. Desiccation, differential settlement, and hydraulic fracture are the most common causes. Cracks parallel to the embankment (longitudinal) are usually less of a problem than cracks transverse (perpendicular) to the alignment of the embankment. Hydraulic fracture is the cause of most cracks in earthen embankments that have failed from internal erosion. The cracks that are opened in an earthfill by hydraulic fracture can extend completely through the earthfill. The cracks can provide flow paths for internal erosion. Hydraulic fracture of an earthfill can occur for several reasons as described in following paragraphs.

Hydraulic fracture can occur in a soil when the water pressure acting on a soil element exceeds the lateral effective stress on the soil. Low lateral stresses are caused by several conditions, most often differential settlement and arching. Arching occurs when soils settle differentially. The presence of a conduit can create conditions favorable for arching. Other factors are also discussed in following paragraphs. Hydraulic fracture usually creates a horizontal plane of weakness in the fill.

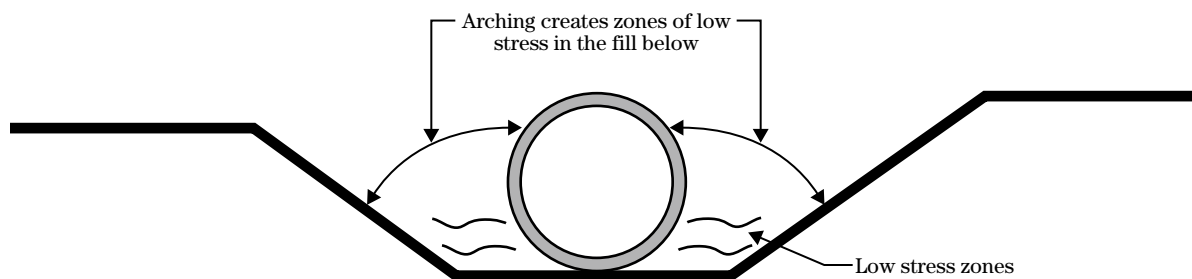
Low lateral stresses can occur under the haunches of conduits that are constructed without cradles or bedding concrete because it is difficult to obtain uniform compaction in that area of earthfills. Operating equipment near the conduit must be limited to avoid damaging the pipe, so hand-held equipment is often used to avoid damage by larger compaction equipment. Hand-compacted soil may have different properties than machine-compacted soils.

Desiccation cracks can occur in moderate to high plasticity soils when fill placement is interrupted during hot, dry weather. Cracks can occur even in as short a period as a weekend. Drying cracks should be removed from fill surfaces before placing the next layer of fill. This precaution will avoid a plane of weakness in the fill which could be prone to hydraulic fracture.

Factors involved in hydraulic fracture are discussed in more detail as follows:

- Arching in compacted fills can create stresses favorable to hydraulic fracture. Figure 45-2 illustrates arching in an earthfill where a trench is excavated to install a conduit. Arching occurs when stresses in the soil in the trench are transferred by friction to the sides of the trench. This allows the low-stress condition in the soils backfilled in the trench. Hydraulic fracture can occur if the reservoir pressure exceeds the lateral stress on the soil elements. A conduit can also create arching below the conduit because the weights of overlying soils are not transferred completely beneath the conduit.
- Sharp changes in bedrock profile or in the profile of any other incompressible horizon, such as a glacial till near conduits, can cause differential settlement, particularly if compressible soil horizons overlie the bedrock. Differential foundation settlements as low as 1.0 foot per 100 feet of horizontal distance is thought capable of creating conditions conducive to hydraulic fracturing. Differential settlement often causes arching in the soils near the anomalies.
- Conduits are often installed in trenches. If the trenches are transverse to the centerline of the embankment differential settlement that can cause arching and hydraulic fracture may occur. If the trench is backfilled with soil compacted to a high-density and low-water content compared to the adjacent foundation soils, the trench soils will have very different compressibility than the foundation soils. This differential settlement can create conditions favorable for hydraulic fracture.
- Embankment soils compacted at or below optimum water content are more likely to be brittle and crack when subjected to differential foundation movements.
- Soils with low plasticity and higher sand content are more susceptible to cracking than higher plasticity soils. Soils considered desirable for the central cores of embankments have a plasticity index (PI) greater than 15. Soils with higher PI values are more flexible and have a reduced hazard of cracking.
- High plasticity soils are more susceptible to developing drying cracks in fill surfaces that are left exposed during interruptions of fill placement. A rule of thumb is that soils with PIs greater than 20 are prone to desiccation. Special attention should be given to inspecting the surfaces of fill layers that are left exposed for more than a day in hot, dry weather when embankments are constructed using these soil types.
- Dispersive clays are probably no more prone to hydraulic fracture than other soils, but these soils are extremely erodible. Hydraulic fracture is more likely to cause a failure in dispersive clay earthfills than with other soils.

Figure 45-2 Arching in earthfill



Factors that reduce the probability of hydraulic fracture of embankments include the following:

- Compacting soils at water contents at least 2 percent above Standard Proctor optimum water content is thought to increase the flexibility of compacted soils. This is particularly important for cohesive fill soils. A good rule of thumb is that cohesive soils should seldom be compacted at a water content less than their plastic limit water content. Another way of stating this important principle is that cohesive soils should never be compacted at a water content less than that at which a 1/8-inch thread will not roll out on a flat surface without cracking. If the soil cracks and crumbles before you can roll out a 1/8-inch thread of cohesive soil, water should be added prior to compaction.
- Flattening the slopes of any excavation transverse to the embankment centerline helps to prevent differential settlement. Usually, stream channel slopes and excavations transverse to the embankment should be flattened to at least 3H:1V slopes. If the embankment soils are especially unfavorable (dispersive clays for instance), slopes no steeper than 4H:1V are recommended.
- Conduits should not be located where a bed-rock profile or other incompressible horizon profile might occur that has sharp differences in elevation.

Those interested in a more thorough discussion of hydraulic fracture should review the article entitled Hydraulic Fracturing in Embankment Dams (Sherard 1986).

628.4503 Filter diaphragm

(a) Introduction

Definition. A filter diaphragm is a designed zone of filter material (usually well-graded, clean sand) constructed around a conduit. It is a standard defensive design measure to prevent problems associated with seepage or internal erosion in earthfill surrounding a conduit.

Purpose. A filter diaphragm is designed to intercept water that can flow through cracks that may occur in compacted fill surrounding conduits or water that may flow along the interface between the conduit and the surrounding fill.

Filter mechanism. Water flowing through cracks in the fill surrounding the conduit may erode soil from the sides of the crack. But, when the flow carrying eroded soil particles reaches a filter diaphragm, the eroded soil particles will lodge on the upstream face of the diaphragm and prevent further crack flow by the filter cake that is created. The intent of a filter diaphragm then is not to act as a drainage zone, but as a crack intercepting and sealing zone.

The theory behind a filter diaphragm is based on extensive testing performed in the NRCS Lincoln, Nebraska, Soil Mechanics Laboratory in the 1980s. Tests demonstrated that even highly erosive clay soils with a pre-formed hole in them would not erode further when protected by a properly designed filter layer of sand (Sherard 1989).

(b) Design of filter diaphragm

Many embankments constructed under both TR-60 and CPS 378 may be designed without internal drainage systems such as chimney filters or transition zones. If an embankment is low or significant hazard and is constructed of soils resistant to internal erosion and piping (not dispersive), the cost of an internal chimney filter is not usually justified. The following recommendations and discussion pertain to designs where the embankment does not contain a chimney filter. If a chimney filter is included in an embankment design, it will serve the combined purpose of a filter

diaphragm to protect against flow around the conduit and protect flow through other sections of the dam. Chimney filters are frequently used for high hazard embankments as additional security against seepage and internal erosion. Designs for embankments constructed of dispersive clays also frequently use a chimney filter because these soil types are highly prone to internal erosion failures.

For most dams, a diaphragm of filter sand surrounding the conduit is relatively inexpensive insurance against failures. The filter diaphragm provides considerable added confidence that water flowing through the embankment outside the conduit will not erode the soils and cause a failure.

(c) Dimensions of filter diaphragms

Appendix A summarizes the recommended minimum dimensions for a filter diaphragm for both CPS 378 and TR-60 embankments. These dimensions are usually adequate, but some conditions require a larger diaphragm. The intent of the diaphragm is to intercept potential cracks in the earthfill and, in some conditions, the diaphragm should be extended.

Appendix A also shows situations where the dimensions of a filter diaphragm should be adjusted and enlarged.

In some cases, the minimum recommended dimensions for a filter diaphragm should be reduced. An example is when bedrock is encountered before the diaphragm dimensions are met.

Appendix A also includes supplemental guidance for locating a filter diaphragm relative to the embankment centerline. The diaphragm should have a minimum thickness of overlying soil adequate to resist uplift pressures from any crack intercepted. The thickness of overlying soil should be no less than half of the difference in elevation between the top of the diaphragm and the top of the dam.

Designs should incorporate an outlet for the filter diaphragm. The drainage diaphragm may be outletted at the embankment downstream toe using a drain backfill envelope continuously along the pipe to where it exits the embankment. Some designs incorporate a zone of gravel in the outlet and some also include

a perforated pipe. Geotextile should not be used as a critical element in the outlet system for filter diaphragms, particularly as a wrapping for perforated collector pipe. Problems with clogging of geotextiles and the location of diaphragms in inaccessible locations make their use inadvisable. Geotextiles can be useful as a separator at an outlet for a filter diaphragm to provide transition between coarse filters and riprap at the toe of the dam. If perforated pipe is used, gravel that is filter compatible with the sand filter used for the drain should be used around the pipe. The gravel must also be designed to be compatible with the size of perforations or slots in the collector pipe it surrounds. A commonly used criterion is that perforations or slots in collector pipes should have a diameter or slot width that is smaller than the D_{50} size of the gravel or sand filter surrounding the pipe. If C 33 sand is used as the filter around the collector pipe, perforated pipe is not suitable for the collector pipe. The size of holes in perforated pipe that would be compatible with C 33 sand are so small that clogging is a likely problem. Slotted pipe may be used to collect seepage in ASTM C 33 sand and a slot width that is about 0.5 mm (0.02 in) or smaller should be specified.

(d) Filter and drain gradation

The gradation of the sands used in the filter diaphragm is important. Standard filter design methods shown in the NEH633.26, should be used to design filters. Materials suitable for filter diaphragms will almost never be available on site and are usually purchased from concrete aggregate suppliers.

Often, design procedures in NEH633.26 will show that ASTM C 33 fine concrete aggregate meets the criteria for filtering the embankment base soils. ASTM C 33 sand usually meets requirements when the embankment soils are in Category 2. This Category includes base soils having between 40 and 85 percent finer than the #200 sieve (after regrading the #4 sieve). However, designers should not assume that ASTM C 33 sand will always be a suitable material for filter diaphragms and should always perform design checks shown in NEH633.26.

In addition to having good filter properties, sands used to construct diaphragms should also be able to deform and fill any cracks that may occur. The term used to describe sands with this property is self-healing.

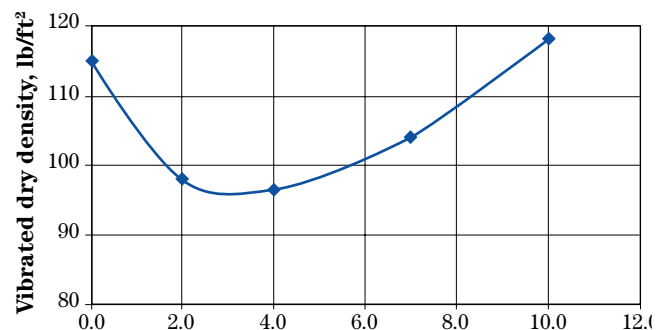
Vaughan (1982) describes a simple test for evaluating the self-healing properties of filters. Figure 45B-2 in appendix B is reproduced from the USACE EM 110-2-1901 that illustrates the Vaughan test. Photographs in figures 45B-3 and 45B-4 show the test being performed on a sand with good self-healing properties and another with poor qualities. Other supplemental tests such as sand equivalency tests and compressive strength tests on molded samples of the filter may provide additional information on the suitability of a filter source. These tests are also briefly discussed in appendix B.

628.4504 Specifications and density quality control for filter sands

Compacting filter sand used in filter diaphragms is important to prevent the filter diaphragm from settling when it becomes saturated. Some fine sands are particularly susceptible to bulking. Bulking can occur when sand in a moist condition is dumped into a trench. At some water contents, fine sands develop strong capillary forces between the particles that resist rearrangement and compaction of the sands. The result is that the sands are in a very loose condition. If the sands are not then compacted or wetted to eliminate the bulking behavior, they will be very loose in the trench. Sands that are placed loosely will consolidate excessively when they are subsequently saturated. This could leave a void above the sand (McCook 1996).

Figure 45-3 shows how important placement water content is to the density obtained from vibration. For this example, the sand, when placed at water contents of about 1 to 7 percent, had a lower vibrated density. Vibratory compactors are usually recommended for compacting sand diaphragms. Note the low density obtained at intermediate water contents. Figure 45-3 shows conclusively the benefit of compacting when the sand is dry or saturating the sand prior to compaction. If sands bulk when placed into a trench for

Figure 45-3 Effect of placement water content on vibrated density



construction of a filter diaphragm, one approach is to flood the trench and thoroughly wet the sands. Another approach is controlled compaction of the filter diaphragm sands. Either method or both may be employed on a particular project. Compaction of gravels has less emphasis because they are not susceptible to bulking.

Compaction for sand filters is usually specified by either a method or performance type of specification. Performance specifications generally require inspection personnel to measure the density of the compacted filter sand using special equipment. The cost of these more elaborate measures for documenting the condition of the compacted filter diaphragms will not be typically justified on structures designed under CPS 378. Most of the time, method specifications will be used on these structures.

(a) Method placement specification

A method placement specification requires the filter sand to be compacted in a specified manner. It does not require a measured density or water content to be obtained. Method placement specifications typically require a particular type of equipment that is operated in a specified manner. The specification assumes that the designer has previous favorable experience with

a specified method and has confidence that the filter sand will have adequate properties if it is compacted using these procedures. An example of method placement specifications is presented below.

For filter diaphragms, using smaller compaction equipment such as walk behind vibratory rollers and plate compactors may be required if working space is limited. Figure 45–4 shows examples of small and medium-sized vibratory compaction equipment that may be specified for filter diaphragms.

Example of method placement specification

- Filter diaphragm sand shall be placed uniformly in layers not to exceed 8 inches thick before compaction. Each layer shall be thoroughly wetted immediately prior to compaction.
- Each layer of sand shall be compacted by a minimum of two passes of a vibratory plate compactor weighing at least 160 pounds. The compactor shall have a minimum centrifugal force of 2,450 pounds at a vibrating frequency of no less than 5,000 cycles per minute (or by a minimum of two passes of a vibratory smooth wheeled roller weighing at least 325 pounds with a centrifugal force of 2,250 pounds at a

Figure 45–4 Small vibratory compaction equipment



vibrating frequency of no less than 4,500 cycles per minute).

- The sand shall be placed to avoid segregation of particle sizes and to ensure the continuity and integrity of all zones. No foreign material shall be allowed to become intermixed with or otherwise contaminate the drainfill.
- Traffic shall not be permitted to crossover filter zones at random. Equipment crossovers shall be maintained, and the number and location of such crossovers shall be established and approved before the beginning of diaphragm placement. Each crossover shall be cleaned of all contaminating material and shall be inspected and approved by the engineer before the placement of additional drain fill material.
- Any damage to the foundation surface or the trench sides or bottom occurring during placement of sand filter shall be repaired before the sand filter zone placement is continued.
- The upper surface of the sand filter zone constructed concurrently with adjacent zones of earthfill shall be maintained at a minimum elevation of 1 foot above the upper surface of adjacent earthfill.

(b) Performance specification

A performance specification requires the filter sand to be compacted to a specified value of dry density. NRCS studies have demonstrated that an excellent reference density for filter sands is that obtained by performing a one point standard Proctor (ASTM D698A) test on a sample of the sand which is thoroughly air-dried prior to performing the test (McCook 1996). Requiring the sand to be compacted to 95 percent of the density obtained in this test has been found to be successful. The following wording is an example of a performance specification for filter sand:

The minimum dry density of the compacted sand shall be equal to 95 percent of the dry density obtained by compacting a single specimen of sand using the energy and methods described in ASTM D698A. The test consists of a one point test performed on sand that has been air dried thoroughly prior to compaction.

628.4505 Quality control

(a) Method specifications

Documented observations of the filter sand placement and compaction are important in verifying conformance to method type specifications. Important steps involved in a quality control inspection of filter diaphragm installations under a method specification include the following:

- Materials should be visually inspected to determine whether they likely meet the material specifications. If a doubt exists, testing should be requested to verify the gradation and quality of the furnished filter sand and gravel.
- The placed materials should be visually inspected to determine that segregation has not occurred from transporting and placing the filters. Broadly graded sands are most prone to segregation. Dropping the materials from heights more than 4 feet also can promote segregation.
- Placement and compaction should be accomplished in lift thicknesses that are no thicker than specified.
- Observations should determine if sands are either placed very dry or that they were wetted immediately prior to compaction with equipment.
- Clean water should be used to wet filter zones to avoid adding clay fines.

(b) Performance specifications

Quality control under this type of specification requires measuring the compacted dry density of representative portions of the filter diaphragm and comparing that to a reference requirement. The wet density and water content of the compacted filter sand must be measured to compute the dry density. Two methods are commonly used for measuring the wet density of the filter:

- Nuclear gage using ASTM D2922
- Sand cone using ASTM D1556

The water content is usually measured by:

- Oven method (ASTM D2216)
- Microwave method (ASTM D4643)
- Calcium carbide tester (ASTM D4944)

The measured dry density of the filter diaphragm is then compared to the required dry density to determine if specifications have been met. A common specification is to require the sand diaphragm to be compacted to at least 95 percent of a one point ASTM D698A energy test on a dry sand sample. Some of the same observations suggested under method specifications should also be documented, particularly those related to material quality, lift thickness, and segregation.

Method specifications require continuously observing the placement of the filter diaphragm to ensure that the sand is wetted properly and that equipment is operated as required. Continuous inspection may not be required for performance specifications because the quality of the compacted filter can be determined after the fact by measuring the density of the compacted sand. Because both types of specifications require observing material quality, lift thickness, and segregation, the major difference in the two specifications is the extra level of testing required by the performance type of specification. If equipment for performing field density tests is not readily available, the performance type of specification may not be advisable. The method type of specification is probably more suitable for CPS 378 category sites.

628.4506 Installation of filter diaphragms

(a) Methods of construction

Two basic methods are used for constructing filter and drain zones in embankment dams. The methods are cut and fill and concurrent construction.

Cut and fill method—In the cut and fill method, the granular filter is constructed by cutting into a previously constructed zone of earthfill to create a trench that can be backfilled with filter material, constructing another interval of earthfill, and then aligning over the filter zone to cut back into it and create the next layer of drain fill. Filter diaphragms are usually constructed by this method as illustrated in figure 45–5. Because this method involves working in a trench that has been excavated in soils, trench safety precautions are extremely important. Personnel who work in excavated trenches should be instructed in proper trench safety precautions and regulations. Seldom is it permissible to have human access to trenches that are over 4 feet in depth. Remotely controlled compaction equipment that can be operated by personnel standing outside the trench should be used when needed.

Concurrent method—In the concurrent method, the zone constructed of granular filter is built more or less simultaneously with lifts of compacted adjacent earthfill. Layers of fill and filter material are concurrently placed and lifts are added as needed to finish the height of filter needed. Figure 45–6 illustrates that this method requires slightly more filter material quantities than the cut and fill method. This method is sometimes also referred to as the Christmas tree configuration. The granular filter surface is usually maintained above the adjacent earthfill to avoid contamination at the filter.

Figures 45–7a through 45–7f show various steps in constructing a filter diaphragm at several typical sites. The figures show excavating a trench for the filter material prior to laying the conduit and then bringing the filter diaphragm up around the sides and over the conduit. Constructing the portion of the filter diaphragm above the top of the conduit is usually by the cut and fill method illustrated in figure 45–5.

Hammer (2003) provides additional valuable discussion on construction of filter zones in embankment dams. The reference includes numerous precautions that are important in constructing filter diaphragms and other filter zones in embankment dams. Figure 45-7e shows a filter diaphragm being constructed around a larger concrete pipe for a TR-60 size embankment.

Figure 45-5 Cut and fill method

- (a) About 3 to 4 feet of compacted earthfill is placed prior to installing the drainage zone.



- (b) A trench is cut in the compacted earthfill that is the width of the excavating equipment. A typical backhoe has a bucket width of about 36 inches (3 ft).



- (c) The excavated trench is backfilled with the filter material, often a gradation similar to ASTM C 33 fine concrete aggregate. The filter is either saturated by flooding, vibrated in lifts, or both to prevent bulking and collapse at some future time.



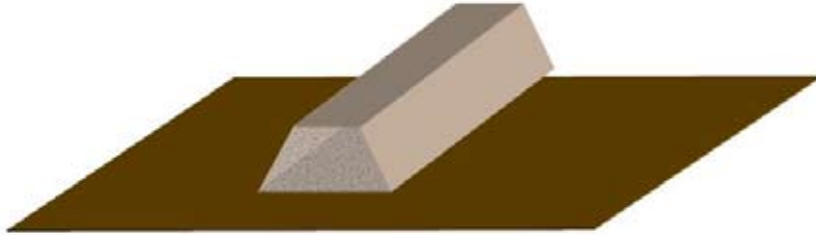
- (d) The next section of embankment is then constructed over the filter trench.



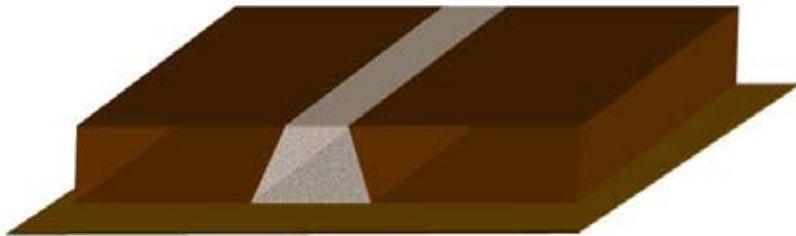
- (e) The process is continued by carefully aligning the excavator over the previously installed filter diaphragm and excavating the current thickness of embankment.



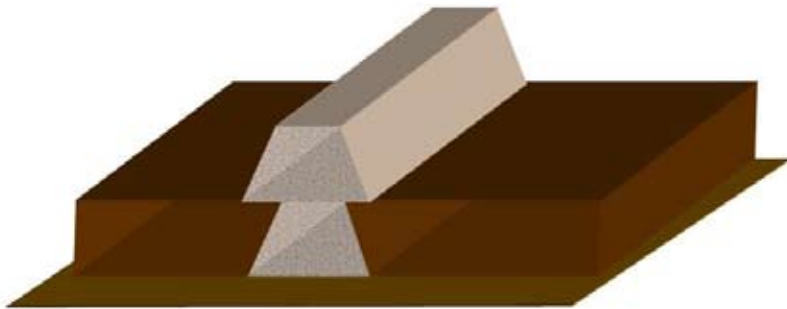
- (f) The excavated trench is backfilled with sand that is placed according to specifications to continue the development of the filter diaphragm. Diaphragms constructed in this manner are usually vertical, but a sloping configuration can be constructed using a wider trench and offsetting each section of trench with each lift of earthfill.

Figure 45-6 Concurrent method

- (a) About 2 to 3 feet of filter is spread evenly along the width of the planned filter diaphragm or chimney filter. If the design for the embankment includes a double filter using a zone of designed gravel downstream of the fine sand filter, the sand and gravel are placed concurrently.



- (b) Earthfill is placed against both sides of the spread filter zone and compacted. Then, the filter sand is compacted either by flooding, vibration, or both.



- (c) The next section of filter is placed after carefully aligning the spreading equipment over the previously constructed zone.



- (d) The process is repeated where embankment soils are compacted on both sides of the previously spread filter materials, and the filters then compacted as specified. Diaphragms constructed by the concurrent method may be either vertical or have a sloping configuration. More vertically oriented zones are constructed by the cut-and-fill method, and more sloping zones are constructed using the concurrent construction method.

Figure 45-6 Concurrent method—Continued

(e) Zones of two different filter gradations are laid.



(f) Filters are then uniformly spread and compacted according to specifications.



(g) Earthfill is compacted on both sides of the filter zones that have been laid. The process is then repeated as the embankment is raised.

Figure 45-7 Filter diaphragm construction

(a) Principal spillway excavated to grade prior to excavating filter diaphragm



(b) Filter diaphragm trench excavated and backfilled with sand



(c) Step 1 in constructing filter diaphragm. Trench has been excavated below grade at location of principal spillway conduit, and sand filter is being compacted in the trench. Conduit will be laid on top of trench after it is filled with filter material compacted to the required degree excavated and backfilled with sand.



(d) Adding water to sand in filter diaphragm excavated below grade of principal spillway conduit prior to compacting

Figure 45-7 Filter diaphragm construction—Continued



(e) Filter diaphragm being constructed to side of principal spillway conduit



(f) Filter diaphragm being constructed above and to both sides of large diameter flexible pipe

628.4507 References

- American Society of Testing Materials. 2005. Designation C33. Standard specification for concrete aggregates. West Conshohocken, PA.
- American Water Works Association. 1996. Concrete pressure pipe, manual of water supply practices. AWWA M9. Denver, CO.
- D'Appolonia, D.J., R.V. Whitman, and E. D'Appolonia. 1969. Sand compaction with vibratory rollers. *Journal of the Soil Mechanics and Foundations Division*, Vol. 95, No. 1, pp. 263–284.
- Hammer, David P. 2003. Construction of vertical and inclined sand drains in embankment dams. ASDSO Annual Meeting, Minneapolis, MN.
- Lee, Kenneth, and Awtar Singh. 1971. Relative density and relative compaction. *Journal of the Soil Mechanics and Foundations Division*, ASCE, Vol. 97, No. SM7, Technical Note, pp. 1049–1052.
- McCook, Danny. 1996. Correlations between a simple field test and relative density test values. American Society of Civil Engineering. *Journal of Geotechnical Engineering*, Vol. 122, No. 10, pp. 860–862.
- McCook, Danny. 2005. Supplemental tests to evaluate suitability of materials proposed for use in critical filter zones. ASDSO Annual Meeting, Orlando, FL.
- Milligan, Victor. 2003. Some uncertainties in embankment dam engineering. *Journal of Geotechnical and Geoenvironmental Engineering*, ASCE. pp. 785–797.
- Polous, Steve. 1988. Compaction control and the index unit weight. *Geotechnical Testing Journal*. ASTM, volume 11, number 2, pp. 100–108.
- Prochaska, Adam Buser. 2004. An alternative method for effective compaction control of granular soils. Thesis for Master Science Degree. Purdue University.
- Sherard, J.L. 1986. Hydraulic fracturing in embankment dams. *Journal of Geotechnical and Geoenvironmental Engineering*, ASCE, 112:905–927.
- Sherard, J.L. 1989. Critical filters for impervious soils. *Journal of Geotechnical Engineering Division*, ASCE. 115:927–947.
- Tavenas, F.A. 1973. Difficulties in the use of relative density as a soil parameter. *In Evaluation of relative density and its role in geotechnical projects involving cohesionless soils*. ASTM Special Technical Publication No. 523, pp. 478–483. E.T. Selig and R.S. Ladd, eds. Philadelphia, PA.
- Tavenas, F.A., R.S. Ladd, and P. La Rochelle. 1973. Accuracy of relative density measurements: results of a comparative test program. *In Evaluation of Relative Density and its Role in Geotechnical Projects Involving Cohesionless Soils*. E.T. Selig and R.S. Ladd, eds. ASTM Special Technical Publication No. 523, pp. 18–60. Philadelphia, PA.
- Tiedemann, D.A. 1973. Variability of laboratory relative density test results. *In Evaluation of relative density and its role in geotechnical projects involving cohesionless soils*. E.T. Selig and R.S. Ladd, eds. ASTM Special Technical Publication No. 523, pp. 61–73. Philadelphia, PA.
- U.S. Department of Agriculture, Natural Resources Conservation Service. 1994. Gradation design of sand and gravel filters. *National Engineering Handbook*, part 633, ch. 26.
- Vaughan, Peter, and Hermosia Soares. 1982. Design of filters for clay cores of dams. *Journal of the Geotechnical Engineering Division*, ASCE, vol. 108, no. GT1, pp. 17–3.

Appendices

Introduction

Embankment dams constructed by the NRCS may be designed by several sets of criteria. The criteria used for design of a particular dam largely depend on the size and hazard class of the embankment. Different criteria are used for large dams and those with significant and high hazard classification than are used for smaller dams with a low hazard classification. Criteria that differ include hydrologic design requirements and others. Criteria related to filter diaphragms are slightly different for the two groups of embankments designed by NRCS. Requirements for the minimum dimensions and location of a filter diaphragm differ for the two groups of embankments. The requirements and guidance for designing filter diaphragms for both groups of embankment types are described in this appendix.

Minimum dimensions for lateral and vertical extent of filter diaphragms

Criteria for dimensions of the diaphragm are given as minimum horizontal and vertical extents. Criteria are the same for the two groups of dams. However, in many cases, the filter diaphragm should be extended further than the minimum extents as described in following sections of this appendix. Generally, for conservatism, diaphragms designed for large and high hazard embankments exceed minimum requirements more often than those for the small and low hazard group of dams. Many large and high hazard dams have embankment chimney filter zones that satisfy the requirements for filter diaphragms and extend much wider and vertically to a greater extent than a filter diaphragm. For dams with a chimney filter, a separate filter diaphragm is not required.

Filter diaphragms may be vertical or on a slope in an embankment. Sloped shapes are often used in zoned dams such as shown in figure 45A-17.

Often, excavations are made for conduit installations, particularly for jobs where an older conduit is excavated and replaced with a new one. In either new or replacement construction, filter diaphragms should extend past interfaces that could be preferential flow paths for water. Excavation side slopes of 3H:1V or flatter are advisable.

Rigid conduits

Filter diaphragms should extend the following minimum distances from the surface of rigid conduits:

- Horizontally and vertically upward—The diaphragm should extend a distance equal to 3 times the outside diameter of circular conduits. For box conduits, the diaphragm requirements are related to the vertical dimension of the conduit. Exceptions are:
 - The vertical extension need be no higher than the elevation of the maximum potential water level in the reservoir, and the diaphragm should extend no closer than 2 feet to the embankment surface.
 - The horizontal extension need be no further than 5 feet beyond the sides and slopes of any excavation made to install the conduit.
 - Figure 45A-1 illustrates the requirements for the horizontal extent of the filter diaphragm for rigid circular conduits.
 - Figure 45A-2 illustrates the requirements for the horizontal extent of a filter diaphragm for rectangular box conduits.
 - Figure 45A-3 illustrates the additional requirement that the filter diaphragm extend at least 5 feet horizontally past the slopes of any excavation made to install the conduit.
 - Figure 45A-4 illustrates the requirement that the diaphragm extend vertically above the conduit a dimension equal to 3 times the diameter of circular conduits or 3 times the height of a box conduit.
 - Figure 45A-5 illustrates the exception to the requirement that the diaphragm extend vertically a dimension equal to 3 times the diameter of the conduit. The diaphragm needs to extend upward to the elevation of the maximum potential water level in the reservoir if that is a distance less than the 3 times Do requirement. It also illustrates a basic requirement that the diaphragm should not be extended to a point where it is less than 2 feet from the embankment surface.

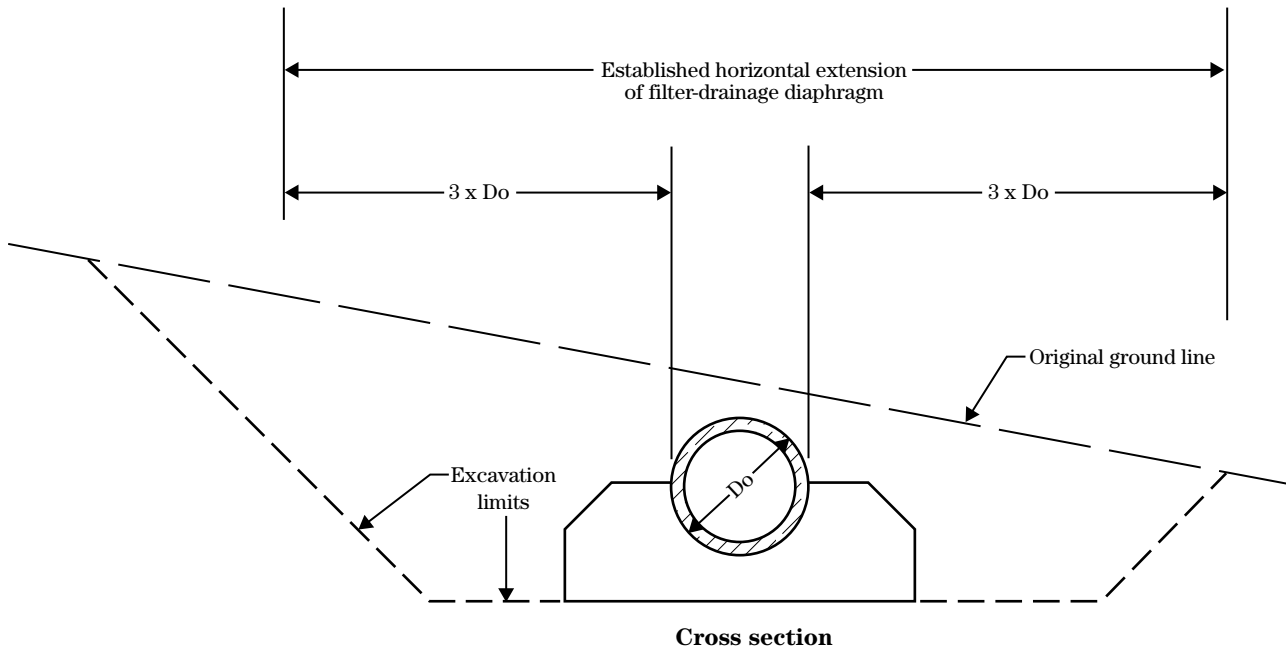
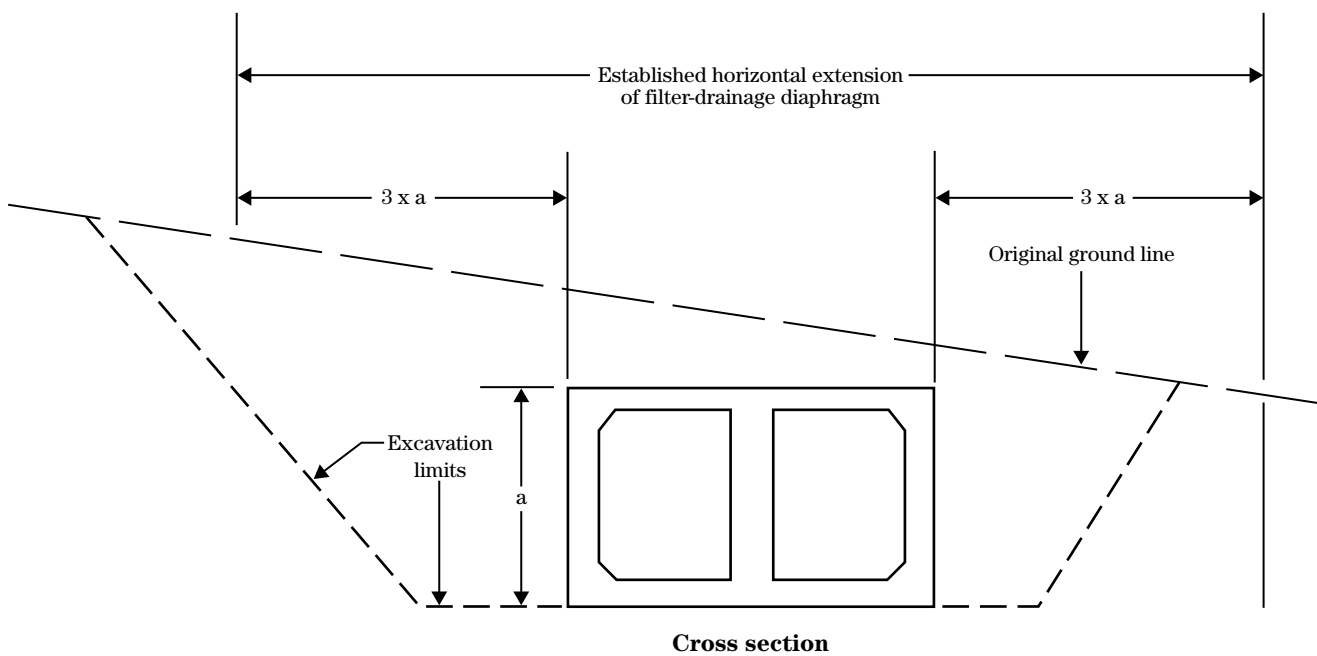
Figure 45A-1 Requirements for the horizontal extent of the filter diaphragm for rigid circular conduits**Figure 45A-2** Requirements for the horizontal extent of a filter diaphragm for rectangular box conduits

Figure 45A-3 Additional notation that the filter diaphragm need not extend more than 5 feet horizontally past the slopes of any excavation made to install the conduit

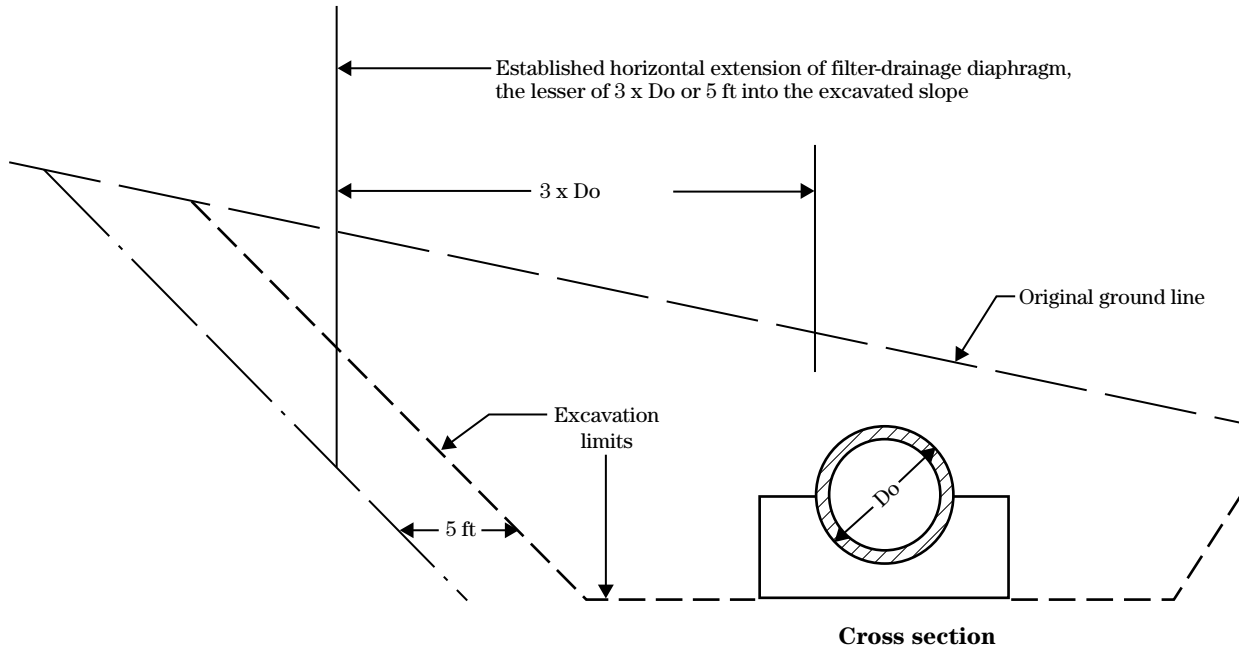
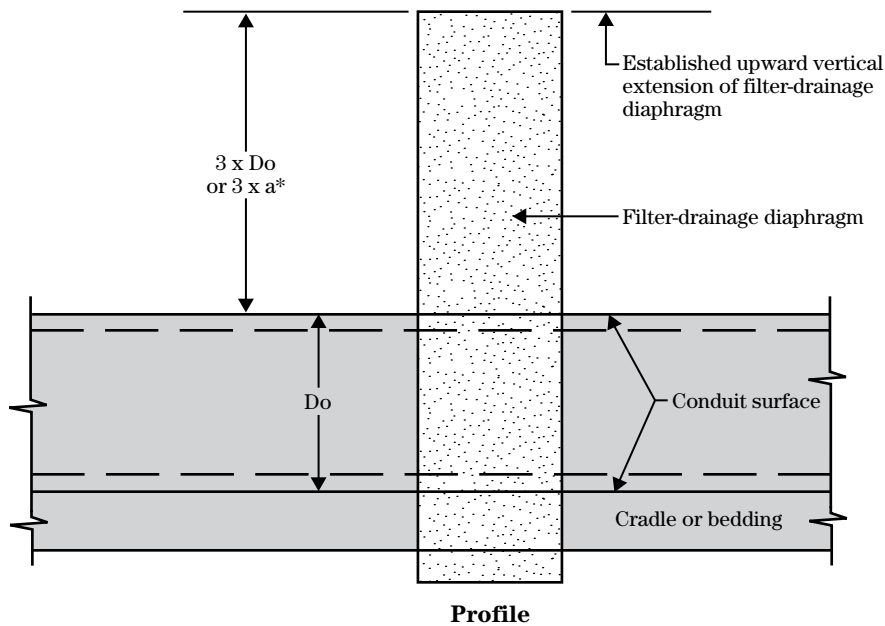


Figure 45A-4 Requirement that the diaphragm extend vertically above the conduit a dimension equal to 3 times the diameter of circular conduits or 3 times the height of a box conduit



* See figure 45A-2 for definition of a

The intent of this guideline is to prevent surface infiltration of rainfall and runoff on the embankment from being collected by the diaphragm. The maximum potential water level may be taken to be the elevation of the auxiliary spillway grade elevation

- Minimum requirements for vertical dimensions below the conduit depend on the estimated conduit settlement ratio, designated with the Greek letter δ . The settlement ratio δ is the ratio of the settlement estimated beneath a conduit divided by the settlement estimated to the side of a conduit. More information on the settlement ratio is described in NEH636.56. Table 45A-1 is reproduced after a reference of the American Water Works Association (1995), showing typical values of settlement ratios.

- For conduits located on foundations with low compressibility, the settlement ratio will typically be above 0.7. Conduits located on compressible foundations will have settlement ratios less than 0.7. Note that the symbol δ is also used to denote total settlement for other purposes such as estimating joint extensibility, and that value should not be confused with settlement ratio. Some references use the symbol r_{sd} to denote settlement ratio. Figure 45A-6 shows the requirement for downward extent of filter diaphragm settlement ratio equal to 0.7 or more.

Figure 45A-5 Exception to the requirement that the diaphragm extend vertically a dimension equal to 3 times the diameter of the conduit

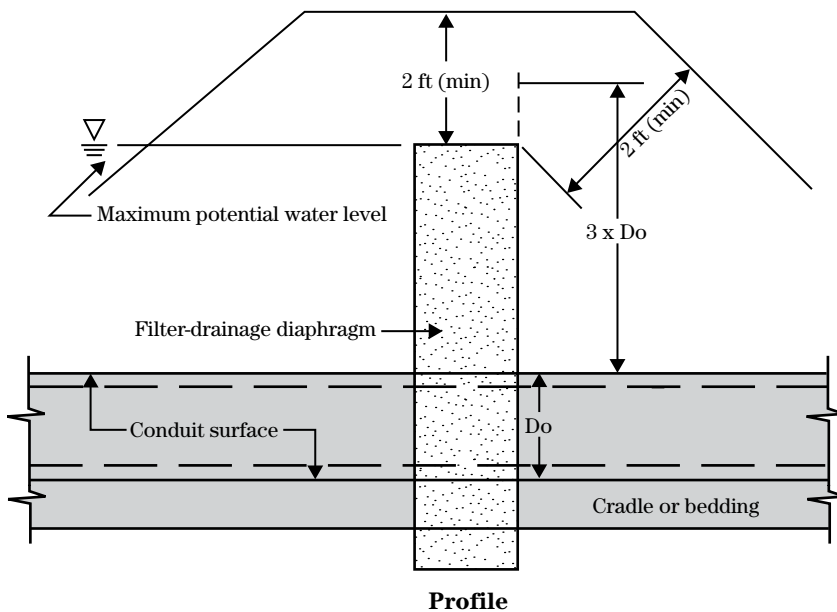
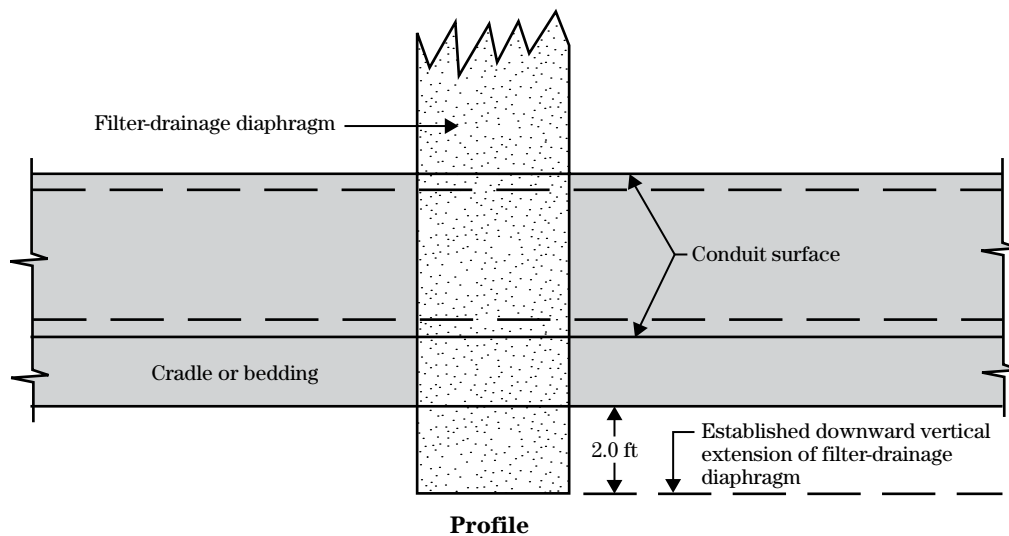


Table 45A-1 Typical values of settlement ratio—positive projecting conduits

Installation and foundation conditions	Settlement ratio	
	Usual range	Typical value
Positive projection	0.0 to +1.0	
Rock or unyielding soil	+1.0	+1.0
Ordinary soil	+0.5 to +0.8	+0.7
Yielding soil	0.0 to +0.5	+0.3
Zero projection		0.0
Negative projection	-1.0 to 0.0	
$\delta = 0.5$		-0.1
$\delta = 1.0$		-0.3
$\delta = 1.5$		-0.5
$\delta = 2.0$		-1.0
Induced trench	-2.0 to 0.0	
$\delta = 0.5$		-0.5
$\delta = 1.0$		-0.7
$\delta = 1.5$		-1.0
$\delta = 2.0$		-2.0

Figure 45A-6 Requirement for downward extent of filter diaphragm settlement ratio equal to 0.7 or more

- For conduit settlement ratios (δ) of 0.7 and greater (low compressibility foundations), the filter diaphragm should extend beneath the conduit the greater of 2 feet or 1 foot beyond the bottom of the trench excavation made to install the conduit (fig. 45A-7).
- If bedrock is encountered at depths shallower than these minimum requirements, the diaphragm may be terminated at the surface of bedrock. Additional control of general seepage through an upper zone of weathered bedrock may be needed (fig. 45A-8).
- For conduit settlement ratios (δ) of less than 0.7 (compressible foundations), extend the diaphragm below the conduit a distance equal to 1.5 times the outside diameter of circular conduits or the outside vertical dimension of box.

Figure 45A-9 illustrates the guidelines for conduits on foundations with settlement ratios of less than 0.7. Note that if bedrock is encountered at shallower depths, the filter diaphragm does not need to extend into bedrock.

Figure 45A-7 Required lower extent of filter diaphragm for settlement ratios of 0.7 or greater when trench is excavated to install conduit

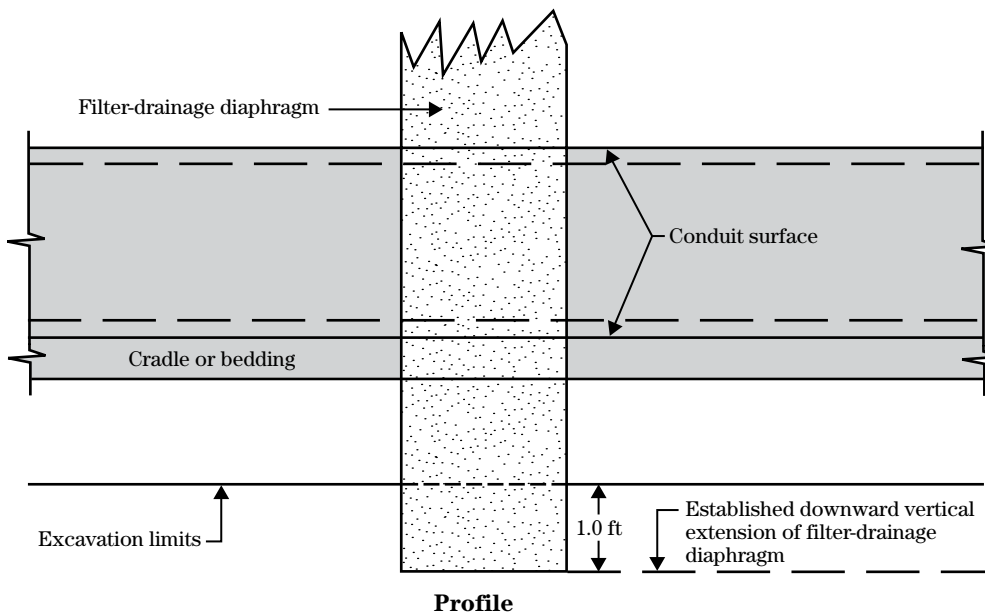


Figure 45A-8 Required downward limits of filter diaphragm when bedrock is encountered above otherwise recommended depths

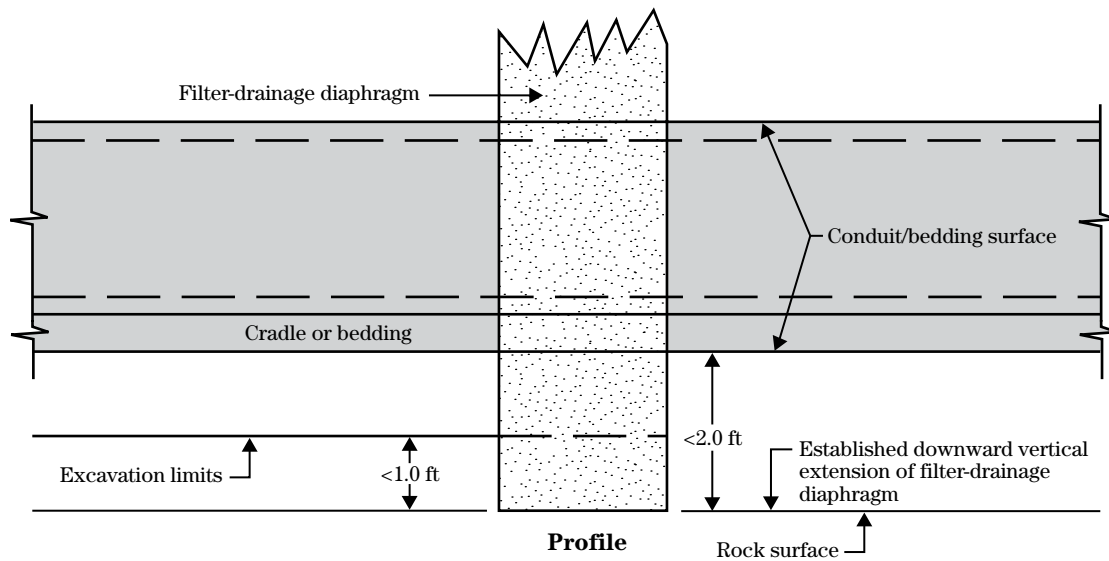
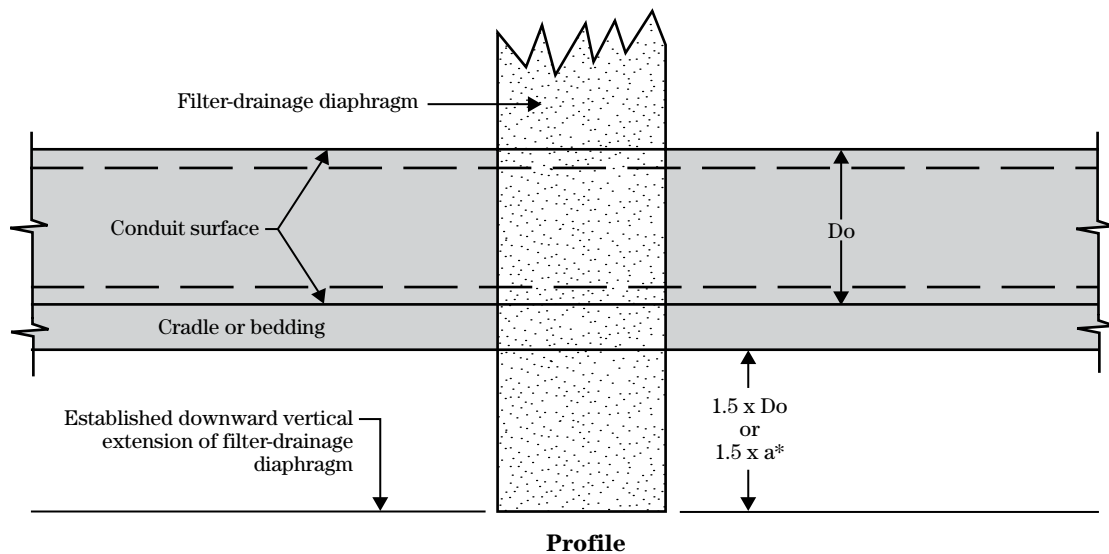


Figure 45A-9 Guidelines for conduits on foundations with settlement ratios of less than 0.7 where no trench is excavated to install conduit and bedrock is not encountered



* See figure 42-A for definition of a.

Flexible conduits

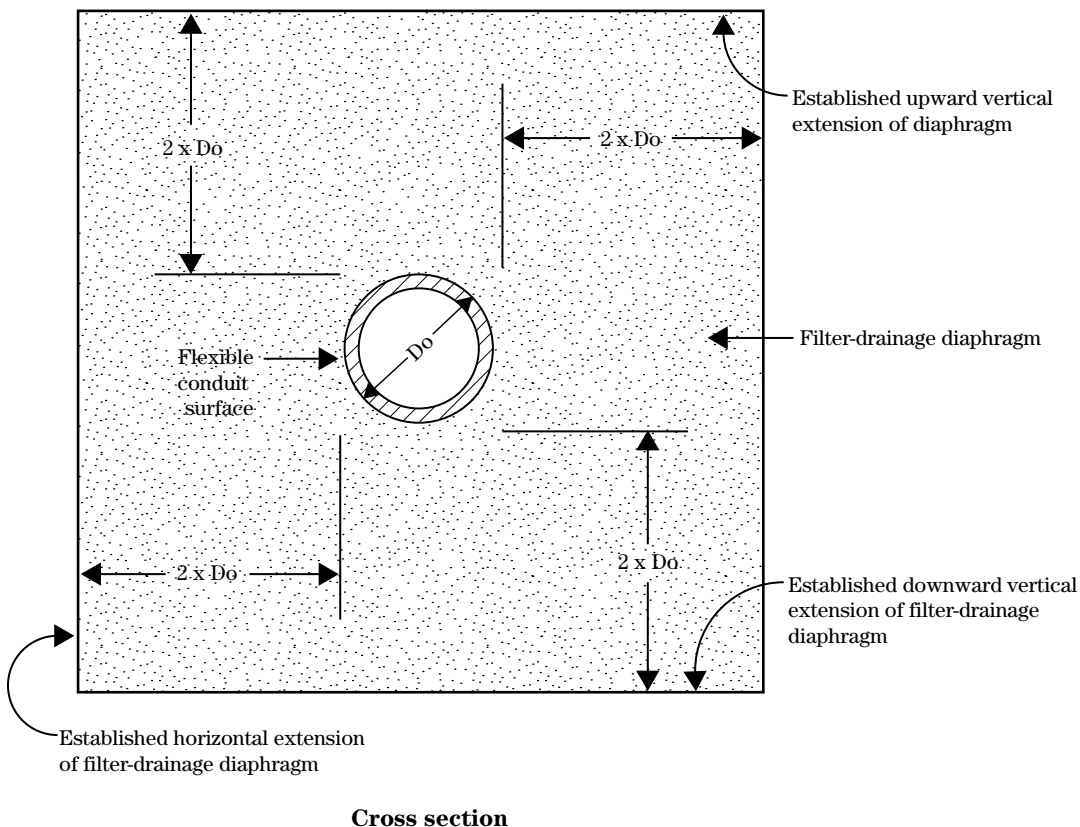
Flexible conduits used on NRCS projects typically consist of corrugated metal pipe (CMP), various types of plastic pipe, steel pipe, or ductile iron pipe. Smaller diaphragms are acceptable for flexible conduits. Several factors allow dimensions as shown in figure 45A-10 to be acceptable for flexible conduits. One is that some flexible pipes such as CMP conduits are very large diameter, as large as 48 inches. Requiring a filter diaphragm to extend 3 times D_o on these size of pipes would result in very large diaphragms. Since flexible conduits are primarily used on structures designed under Conservation Practice Standard 378, requiring this large a diaphragm encompasses all parts of the surrounding fill that could be susceptible to hydraulic fracture. The filter diaphragm should extend laterally into slopes of any excavation made to install the conduit.

Design the diaphragms to extend in all directions a minimum of two times the outside diameter from the surface of flexible conduits, except that the diaphragm need not extend beyond the limits in figures 45A-8 and 45A-9 or beyond a bedrock surface beneath the conduit (fig. 45A-10).

Thickness requirements for two groups of dams

The filter diaphragm should be aligned approximately parallel to the centerline of the dam or approximately perpendicular to the direction of seepage flow. The diaphragm should be about perpendicular to the conduit unless the conduit is skewed (not perpendicular to the embankment centerline). The diaphragm should be parallel to the embankment centerline in all cases. The primary difference in requirements for filter dia-

Figure 45A-10 Minimum extent of filter diaphragm for flexible conduits



phragms relates to the thickness of the diaphragm that is required (width of the diaphragm parallel to flow, or in an upstream/downstream direction). Diaphragms for large and moderate to high hazard embankments are required to be a minimum of 3 feet thick parallel to the direction of flow. Small embankments that are also low hazard may be designed with a filter diaphragm that is 2 feet thick. Figure 45A-11 illustrates the minimum thickness requirement for large and significant to high hazard embankments. Refer to other criterion documents of small, low hazard terminology.

If a two-stage configuration is used for the filter diaphragm (zones of both sand and gravel for increased capacity), the minimum diaphragm thickness is 3 feet

for both groups of dams. Any zone in a multizone system should be at least 1 foot thick. Use thicker zones if they are needed for capacity, or they are needed to tie the filter diaphragm into other embankment or foundation drainage systems. Wider zones may also be needed to accommodate construction methods, or for other reasons (fig. 45A-12).

Two-stage zoning of filter diaphragms is seldom needed. An instance where a two-stage zone might be required is in the case of a zoned dam where the downstream zone is much coarser than the upstream zone. The two-stage diaphragm would be needed for transition between the two very different zones.

Figure 45A-11 Minimum thickness requirement for large and significant to high hazard embankments; small, low hazard dams may use a 2.0 ft minimum thickness

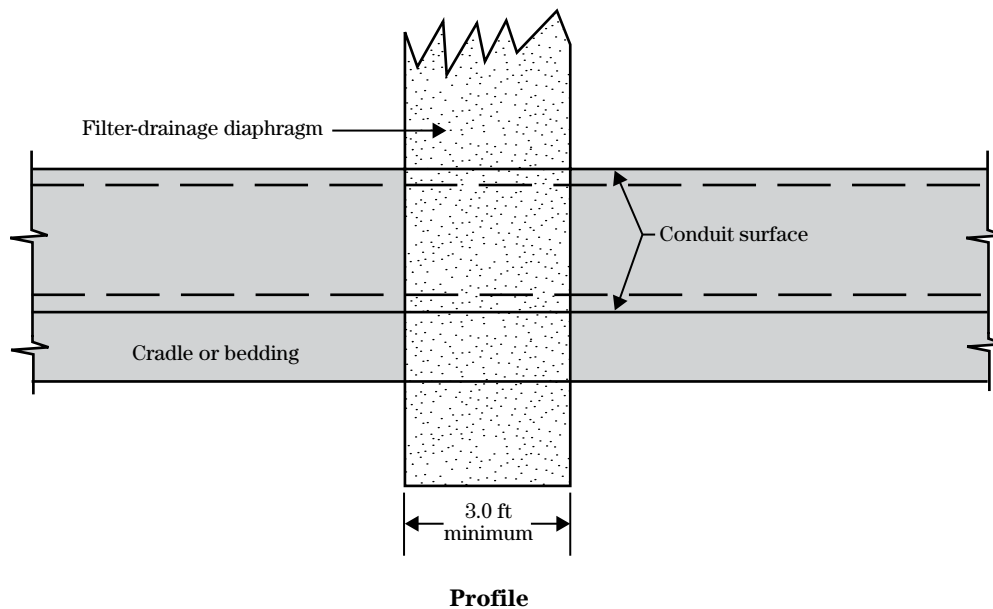
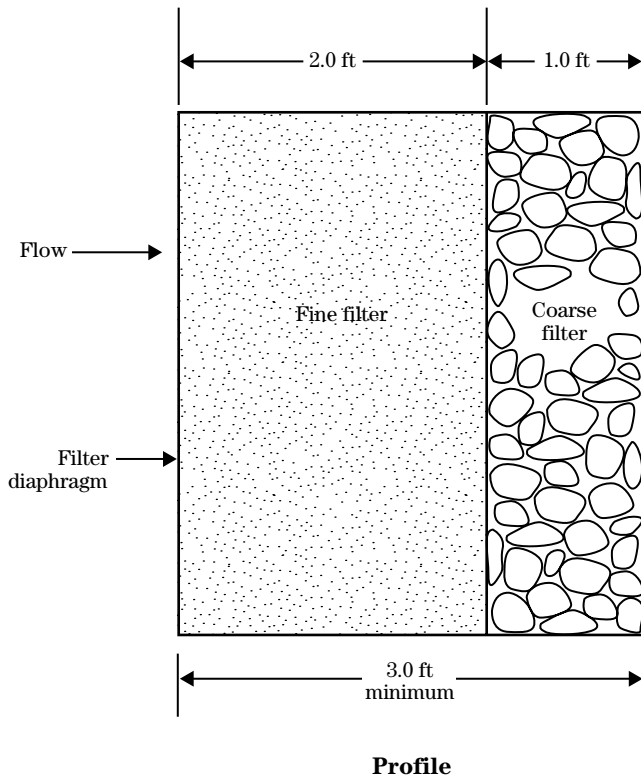


Figure 45A-12 Minimum dimensions of zones in a two-stage filter diaphragm



Note: The minimum combined total thickness of the filter diaphragm and the coarse zone is 3 feet.

Location of the conduit referenced to centerline of the embankment

For homogeneous dams, locate the diaphragm in the downstream section of the dam such that it is:

- downstream of the cutoff trench (fig. 45A-13)
- downstream of the centerline of the dam when no cutoff trench is used (fig. 45A-14)
- upstream of a point where the embankment cover (upstream face of the diaphragm to the downstream face of the dam) is at least half of the difference in elevation between the top of the diaphragm and the maximum potential reservoir water level. The downstream edge of the filter diaphragm shall be no less than 2 feet from the downstream embankment slope. The basis of this requirement is that if the filter diaphragm intersects a crack in the embankment, the diaphragm could be subject to the reservoir pressure in that crack. The diaphragm should

have enough weight of overburden to counter this hydrostatic stress. Because soils typically have a unit weight that is about twice the unit weight of water, if the thickness of overburden is twice the head in feet of water, there should not be excessive uplift. The 2-foot minimum is to prevent surface runoff and rainfall from easily infiltrating into the diaphragm.

- For zoned embankments, locate the diaphragm downstream of the core zone and/or cutoff trench, maintaining the minimum cover as indicated for homogeneous dams. When the downstream shell is more pervious than the diaphragm material, locate the diaphragm at the downstream face of the core zone. It is good practice to tie these diaphragms into the other drainage systems in the embankment or foundation (figs. 45A-16 and 45A-17).

Appendix C includes detailed examples of how to size outlet zones for filter diaphragms.

Figure 45A-13 Downstream of the cutoff trench

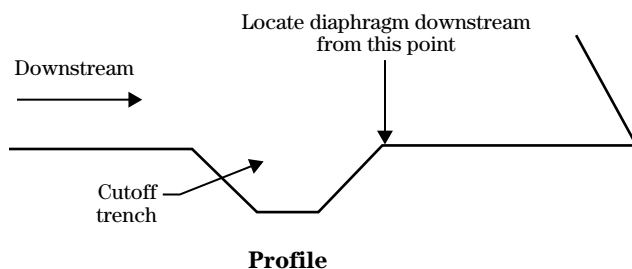


Figure 45A-14 Downstream of the centerline of the dam when no cutoff trench is used

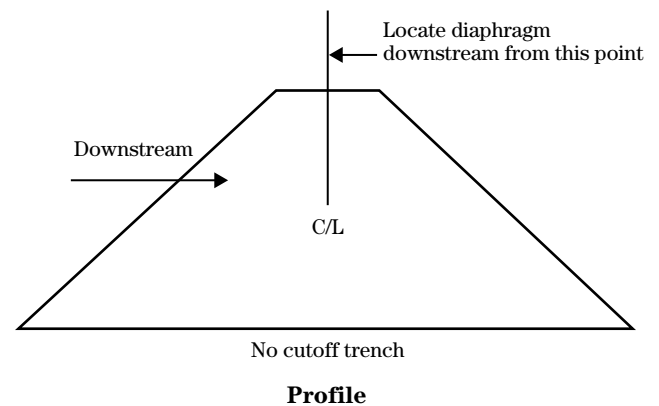


Figure 45A-15 Upstream face of the diaphragm in relation to the downstream face of the dam

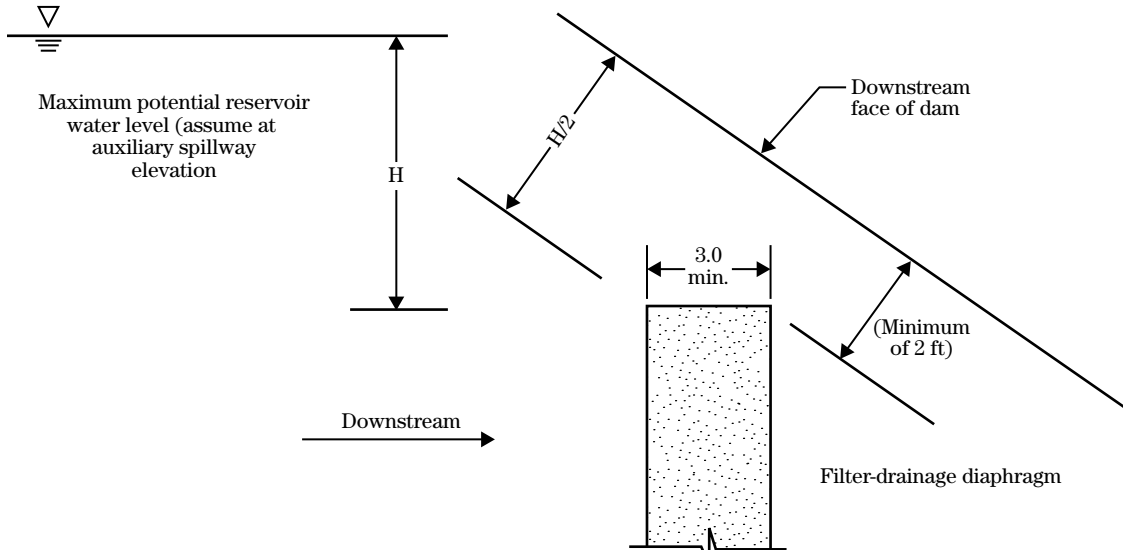


Figure 45A-16 Zoned embankments

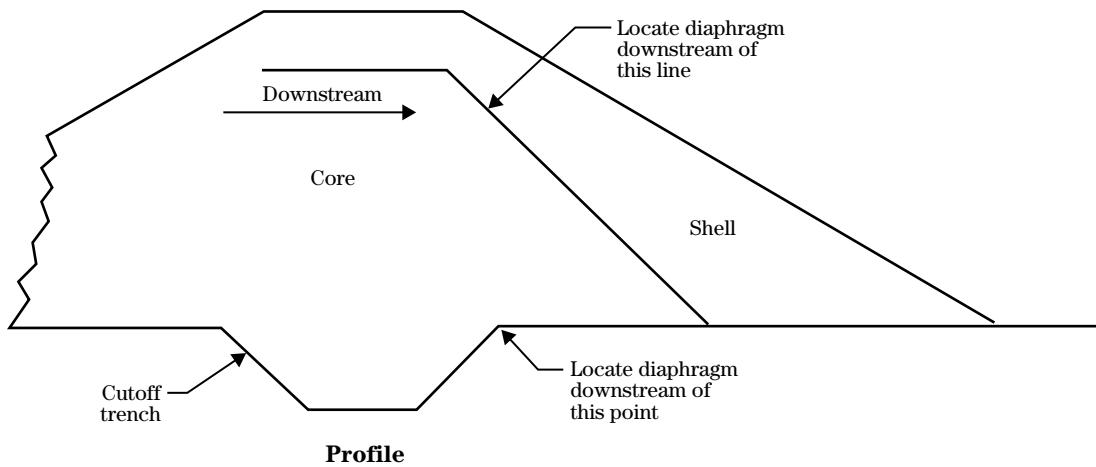
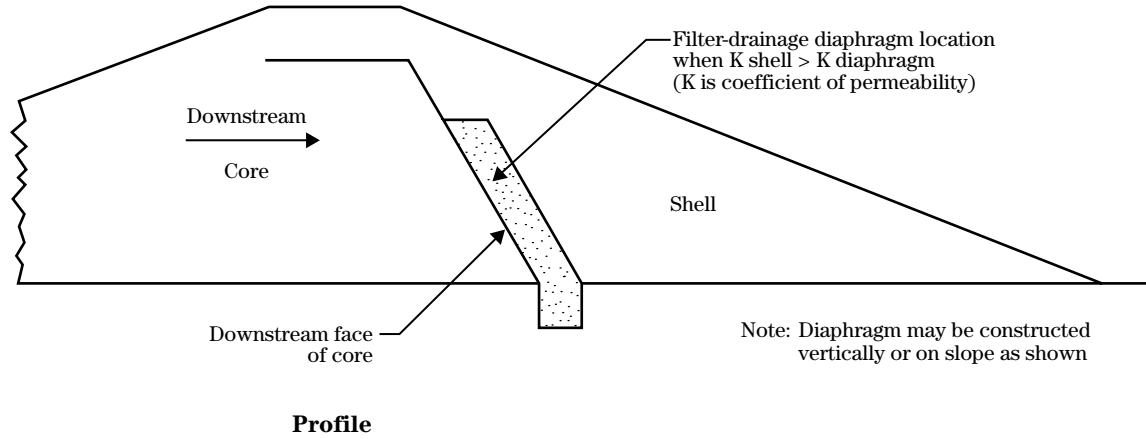


Figure 45A-17 Zoned embankments



Introduction

Fine concrete sand that meets the requirements of ASTM C 33 is often specified and used to construct filter diaphragms. This gradation of sand meets the filter requirements for many embankment soil types according to criteria in chapter 26, part 633 of the NEH. The gradation of sand specified in ASTM C 33 fine concrete aggregate is especially well-suited to soils in Group 2 of chapter 26. These soils have between 40 and 85 percent finer than the #200 sieve (after regrading on the #4 sieve).

ASTM C 33 specifications are adequate to ensure that the proper gradation is furnished, but supplemental tests are often performed to assess properties of sands other than gradation. To satisfy the function of a filter diaphragm, sands should be “self-healing.” This refers to the ability of a sand to adjust and fill any cracks that may form in the surrounding earthfill. A filter diaphragm zone should not be able to sustain a crack through itself if it is to function satisfactorily.

Several supplemental tests including the Vaughan and Soares Test, the sand equivalency test, and a compressive strength test may be useful to verify the self-healing characteristics of sands used to construct a filter diaphragm. Figure 45B-1, reproduced from the USACE EM 1110-2-1901, Embankment Seepage Control, illustrates the reason concern exists for filters with poor self-healing properties. If a crack can propagate through a filter, the filter will not function as intended.

Vaughan and Soares test

This test was described in an article written for the ASCE Geotechnical Journal in 1981. The test consists simply of compacting a sample of the sand, allowing the sample to air-dry, and then slowly submerging the sample in a pan of water. Sand with good self-healing characteristics will collapse as the water submerging the sample destroys the capillary stresses that are supporting the sample. A sample with poor self-healing characteristics probably has excessive fines or chemical cementation that causes it not to collapse when saturated.

Figure 45B-2 is a figure reproduced from the USACE EM 1110-2-1901, Embankment Seepage Control. The figure illustrates how the Vaughan test is performed.

Figure 45B-3 shows photographs of Vaughan and Soares test specimens on a sample with poor self-healing characteristics, and figure 45B-4 shows photographs of specimens with good self-healing characteristics.

Sand equivalent test

The sand equivalent test has been more widely used in qualifying aggregates used for production of asphalt and concrete than for filters. However, it may be useful to show the relative proportions of fine dust or clay-like materials in aggregate (or soils). The test is commonly performed in geotechnical laboratories and is relatively inexpensive. The test is ASTM standard test method D2419.

A sample of aggregate passing the 4.75 mm (#4) sieve and a small amount of flocculating solution are poured into a graduated cylinder and are agitated to loosen the clay-like coatings from the sand particles. The sample is then irrigated with additional flocculation solution forcing the clay-like material into suspension above the sand. After a prescribed sedimentation period, the height of flocculated clay and height of sand

Figure 45B-1 Importance of self-healing properties in filter diaphragms

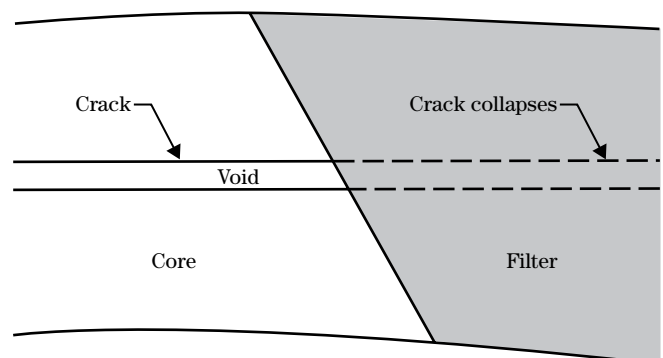


Figure 45B-2 Vaughan and Soares test for self-healing characteristics

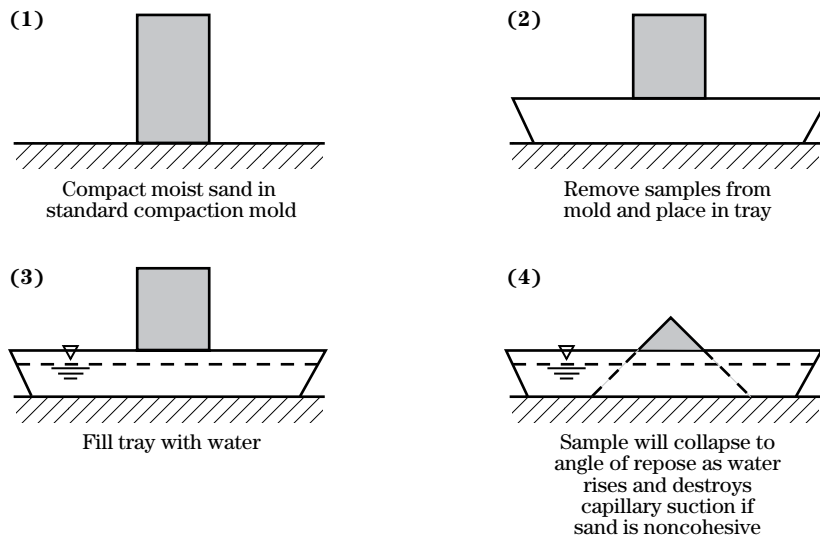


Figure 45B-3 Vaughan and Soares test on sample with poor self-healing characteristics. As sample is submersed, capillary stresses are reduced and sample should collapse. This sample does not collapse on wetting, demonstrating poor self-healing characteristics.



are determined. The sand equivalent is determined from the following equation:

$$\text{sand_equivalent} = 100 \times \frac{\text{height_sand}}{\text{height_clay}}$$

Sands that have the most favorable properties would have relatively low clay content, which would cause the value of the sand equivalent to be higher. Specifications for aggregates to be used for concrete typically require the aggregates to have sand equivalent values of 70 or higher. One state Department of Transportation (DOT) requires a value of 80 or higher. Because a limited number of filter sand samples have been tested by the NRCS, a final evaluation of the usefulness of the test was not available at the time of publication of this document.

Compressive strength

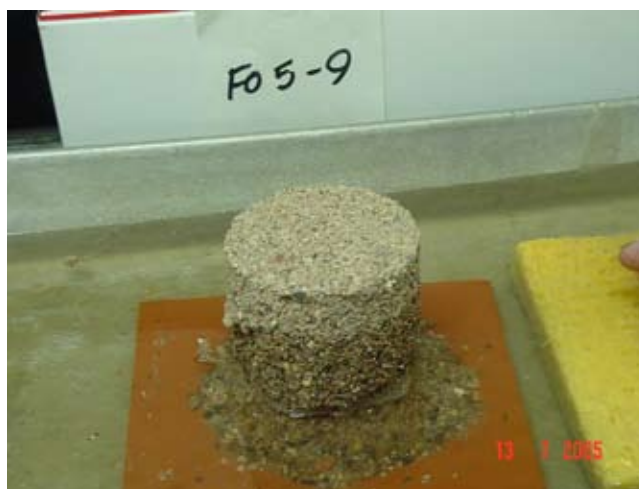
Another test with some promise in identifying sands with unfavorable properties for use in a filter diaphragm is a compressive strength test. McCook (2005) describes the test in detail. Sands with high values in the compressive strength test probably have poor self-healing properties, because the high compressive strength intuitively reflects cementation in the sand.

More research is needed to define a value of compressive strength that clearly defines unacceptable self-healing properties. Figure 45B-5 shows a compressive strength specimen. This sample of fine concrete aggregate satisfied the requirements for gradation in ASTM C 33, but it had a high compressive strength that reflected cementitious properties that are not favorable for good self-healing properties.

Figure 45B-5 Compressive strength specimen



Figure 45B-4 Vaughan and Soares test on sample with good self-healing characteristics. As sample is submersed, capillary stresses are reduced and sample collapses quickly.



Introduction

A filter diaphragm in an earthen embankment may have several purposes that it satisfies simultaneously as described in the body of chapter 45. The primary purpose of a filter diaphragm is to intercept any cracks that may occur in the earthfill surrounding a conduit passing through the embankment, collect fines being eroded from the sides of the crack, and stop the flow in the crack. This occurs when a filter seal forms from the accumulation of the eroded fines carried with the water flowing along the crack at the interface of the crack and filter diaphragm. The ability of a correctly designed filter to intercept cracks and create a filter seal at the interface of the crack and filter has been well established by laboratory research and the successful performance of many installations.

A secondary purpose of a filter diaphragm is to intercept normal seepage through the portion of the embankment upstream of the diaphragm. The collected seepage can be conveyed safely in a controlled manner to an outlet near the downstream toe of the dam.

A filter with the correctly designed gradation will have the required combination of filtering capability and permeability to satisfy both of these functions simultaneously. To ensure that the filter diaphragm and the outlet used to convey the collected flow to the downstream toe have adequate capacities, certain design procedures are necessary. Appendix A covers the basic dimensions required for filter diaphragm cross-sections. Appendix C provides more detailed design examples to illustrate how to size the outlet for a filter diaphragm correctly.

The outlet for a filter diaphragm typically consists of a zone of filter sand or a two-stage zone of sand with a gravel core that extends from the base of the filter diaphragm to the vicinity of the downstream toe of the dam. The strip drain typically is installed to either side of the conduit as shown in illustrations that follow. The capacity of the outlet zone should be designed so that the hydraulic head does not exceed the depth of the drain outlet (no piezometric pressure above the drain). Where the drain exits the downstream slope, the granular materials in the drain should be protected from erosion and instability due to seepage pressures in the drain. Covering the outlet with coarser granular zones designed to be filter compatible with the filter strip materials including small riprap is appropriate.

Perforated collector pipes may be used to increase the capacity of outlet strip drains, but they must be surrounded by gravel zones that have a gradation designed for the size of perforations in the collector pipe. Collector pipes should have clean-out traps to allow inspection and clean out. The collector pipes must be structurally designed to resist the weight of overlying embankment materials. If the pipe corrodes, is crushed by exterior loading, or is otherwise damaged, the outlet of the filter diaphragm is negated. In most cases, a pipe outlet without a surrounding filter zone is discouraged. The design life of the pipe must be consistent with the design life of the dam and physical conditions of the site.

The size of collector pipe and the number and diameter of perforations should be based on predicted seepage quantities. The pipe must be designed for capacity and size of perforations as outlined in Soil Mechanics Note 3.

In most cases, the outlet strip drain should be designed to have adequate capacity without relying on the capacity of a collector pipe, particularly if the pipe could become clogged from iron ochre, may deteriorate, or become crushed during its life. The collector pipe should usually be considered only as providing additional safety, and not the principal method for conveying the collected water to the toe of the dam.

Assumptions

Certain basic assumptions are recommended when computing quantities related to seepage and intercepted crack flows. These assumptions are summarized as follows:

- In computing seepage flows through the embankment intercepted by the filter diaphragm, assume the permeability of the soils in the embankment are equal to 100 times their actual permeability. This provides a safety factor appropriate for the uncertainties involved.
- The seepage cross section of the embankment should be assumed to be equal to the cross-sectional area of the filter diaphragm viewed in elevation.
- The seepage distance for flow through the embankment upstream of the filter diaphragm may be approximated as equal to the distance

from the upstream toe of the embankment to the filter diaphragm at its contact with natural ground.

- Seepage computations to establish the required capacity of outlet drain zones should consider tailwater at the highest likely elevation in assigning hydraulic heads for the flow (fig. 45C-1).
- The exposed granular outlet drain material at the point the outlet intersects the downstream slope of the embankment must be protected from erosion and slope instability due to horizontal seepage forces. The preferred method is a zone of small riprap size rocks that is filter compatible with the outlet gravel envelope. Nonwoven geotextile may also be used to separate the outlet strip drain from the riprap protection zone.
- The basic method for sizing the outlet drainage zone for filter diaphragms is application of Darcy's Law:

$$Q = K \times i \times A$$

where:

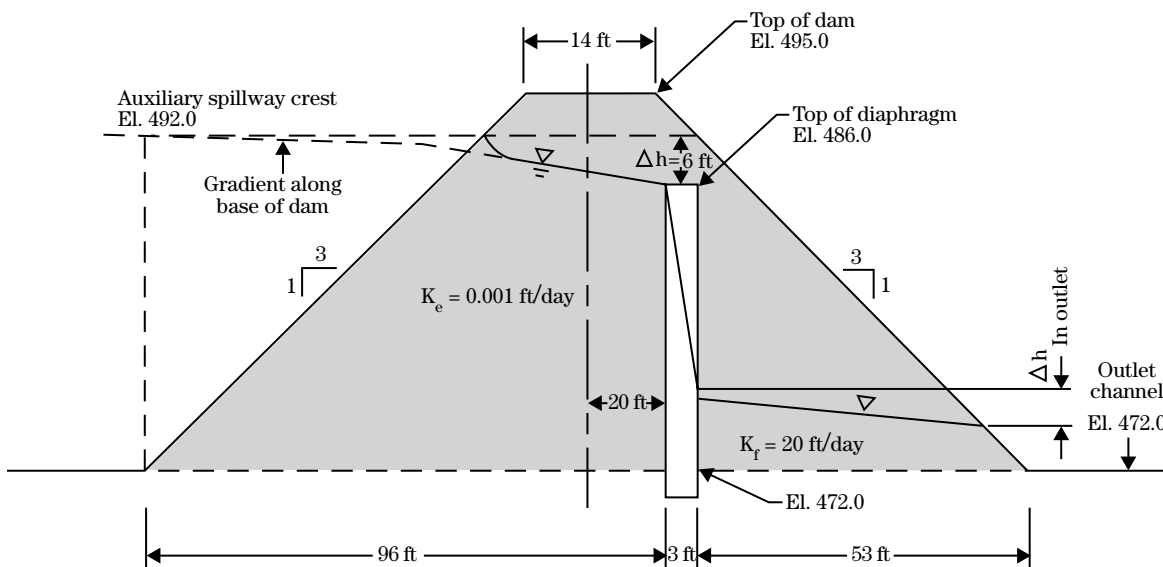
K = coefficient of permeability of the material conveying flow. For some computations, the material is the soil upstream of the embankment, and for others, the material is the outlet granular filter zone conveying the flow to the downstream toe of the dam

i = the hydraulic gradient causing flow. Hydraulic gradient is the ratio of the head differential causing the flow divided by the length of the flow path:

$$i = \frac{\Delta h}{\Delta l}$$

A = the cross-sectional area of flow. In some computations, the area is the cross-sectional area of the filter diaphragm. In computing the capacity of the outlet drain, it is the cross-sectional area of the outlet drain. For outlet drains composed of two materials, use only the area of the coarse drain zone to compute the flow capacity. The fine drain zone in a multiple zone outlet is considered only for its filter function and for conservatism; no credit is given to its contribution to capacity.

Figure 45C-1 Embankment cross section for example 1



Design examples

The two design examples that follow assume that the embankment material is isotropic, or that the horizontal permeability and vertical permeability are equal. Often, in compacted embankments, the horizontal permeability will be a multiple of the vertical permeability, usually from 9 times up to 25 times higher. The higher estimated permeability, usually the horizontal permeability, should be used for computations. As noted above, for conservatism, assume for computations of capacity that the permeability is at least 100 times the actual estimated value of horizontal permeability of the embankment. Design examples use this principle.

Example 1 provides a solution that strictly adheres to the requirements of TR-60 for calculating the design outlet quantity. This method also uses the outlet depth of flow for proportioning the thickness of the drain-fill needed for the outlet (not specifically required in TR-60).

Example 2 is a less conservative design that takes advantage of one of several accepted NRCS methods of

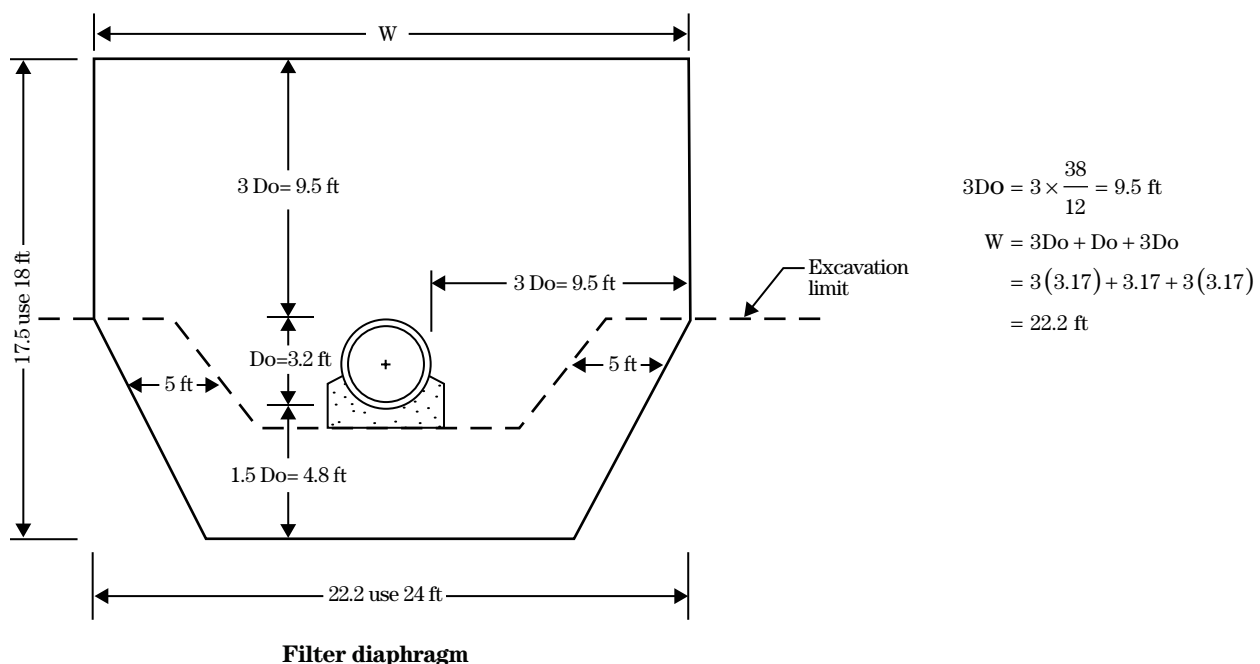
estimating seepage through embankments. The method used in example 2 uses the average depth of flow in the outlet for establishing the required thickness of the outlet. This example is presented to illustrate a more rational approach to the design problem.

Example 1

This example illustrates a process for sizing an outlet strip drain for a filter diaphragm. This example assumes an embankment as shown in figure 45C-1. The conduit through the embankment has an outside diameter of 38 inches. The dimensions of the filter diaphragm using recommended guidelines are about 18 feet vertically and 24 feet horizontally, with the conduit located in the cross section as shown in figure 45C-2.

The coefficient of permeability of the embankment is 0.001 foot per day (3.5×10^{-7} cm/s), and the permeability of the filter diaphragm sand is 20 foot per day (7×10^{-3} cm/s). The top of the filter diaphragm is 6 feet lower than the crest of the auxiliary spillway, and the filter diaphragm is 3 feet wide. The distance from the filter diaphragm to the downstream toe is 53 feet.

Figure 45C-2 Filter diaphragm for example 1



To compute the size of outlet required to convey the seepage collected by the filter diaphragm to the downstream toe of the dam, perform the following computations. The first set of computations is to determine the quantity of flow conveyed through the embankment upstream of the filter diaphragm. That flow will need to be collected and conveyed to the downstream toe of the dam. Darcy's Law $Q = K \times i \times A$ is used to compute flow through the embankment.

Step 1 First, the area of embankment contributing flow to the diaphragm is computed:

$$A_{rd} = 18\text{ft} \times 24\text{ft} = 432\text{ft}^2$$

Step 2 Compute the hydraulic gradient i , which is equal to Δh divided by Δl . Referring to figure 45C-1, Δh is 6 feet and Δl is 96 feet. The term Δh is assumed to be 6 feet, because the top of the filter diaphragm is set 6 feet below the assumed water height in the reservoir. In a case where the filter diaphragm extended to the same height as the assumed height of water in the reservoir, one would need to assume some reasonable amount of head loss between the point where the water line intersects the upstream slope and the filter diaphragm.

Tools such as Casagrande's method for constructing a parabolic phreatic surface can be used. See Soil Mechanics Note SM-7 for more information. The term Δl is 96 feet from the dimensions in the design. Then,

$$i = \frac{\Delta h}{\Delta l} = \frac{6}{96} = 0.0625$$

Step 3 For conservatism, assume the embankment permeability is 100 times the actual estimated permeability. This is a requirement in NRCS criteria documents.

$$K = 100 \times K_{emb} = 100 \times 0.001\text{ft/day} = 0.10\text{ft/day}$$

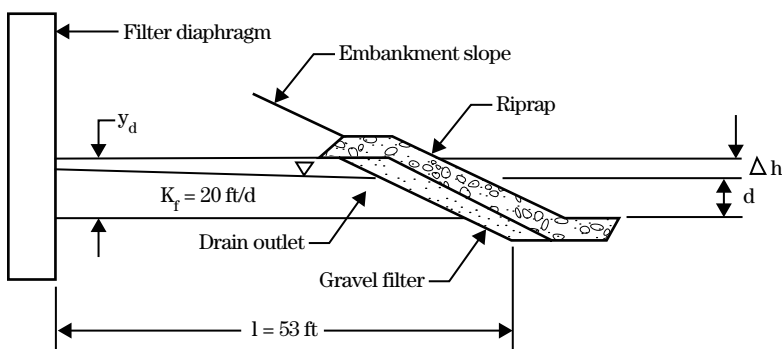
Step 4 Compute the design Q using Darcy's Law

$$Q = K \times i \times A$$

$$Q = 0.10\text{ft/day} \times 0.0625 \times 432\text{ft}^2 = 2.7\text{ft}^3/\text{day}$$

Step 5 Refer to figure 45C-3 for the assumed dimensions of the outlet section that will convey seepage collected by the filter diaphragm to the downstream toe.

Figure 45C-3 Profile of drain for example 1



Profile of drain

Step 6 The initial dimensions of the strip drain are derived as follows. First, assume the strip outlet drain is being installed in an excavation made along the conduit that has a 12-foot bottom width (fig. 45C-4). A designer could use other assumed widths, but 12 feet is commonly assumed because it is the width of many pieces of earth moving equipment. Because the conduit is given to have an outside dimension of 38 inches (3.2 feet), the width of filter on each side of the conduit is $(12 - 3.2) \div 2 = 4.4$ feet. The height of the cross section, y_d , is obtained in the solution.

Step 7 Refer to figure 45C-3 for a definition sketch of the profile along the filter diaphragm outlet. To solve for values of y_d , prepare a tabular computation as shown. First assume a range of values of head loss that can occur in the drain, Δh . For the example, values between 0.4 and 1.4 are assumed. Next, compute values of i corresponding to these values of Δh , using the definition of $i = \Delta h \div \Delta l$. From the definition sketch figure 45C-3, the l distance is 53 feet.

Assume the permeability of the outlet strip which is composed of C 33 concrete sand to be 20 feet per day. Darcy's Law then solves for the Q in drain as follows:

$$Q = K_{\text{filter}} \times i \times A$$

From step 6, Q that is collected by intergranular seepage in the filter diaphragm that needs to be conveyed to the outlet was 2.7 ft³ per day.

Rearranging and solving for A :

$$A = \frac{Q}{K_{\text{filter}} \times i} = \frac{2.7}{20 \times i}$$

From step 4 (fig. 45C-4), the flow area A is equal to

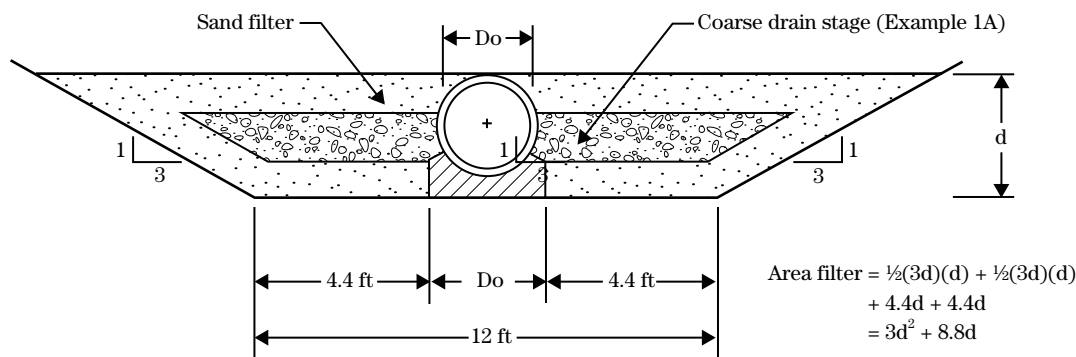
$$A = 3 \times d^2 + 8.8 \times d$$

Putting this into the form of the quadratic equation then:

$$3d^2 + 8.8d - A = 0$$

Substituting values for A corresponding to the range of i values computed allows completion of the table for values of d corresponding to the range of assumed values of Δh . To complete the table, from the definition sketch, figure 45C-3, y_d is equal to $d + \Delta h$.

Figure 45C-4 Two-stage drain



Δh , ft	i *	A ** ft ²	d *** ft	y_d ft
0.4	0.008	17.888	1.382	1.782
0.6	0.011	11.925	1.008	1.608
0.8	0.015	8.944	0.799	1.599
1.0	0.019	7.155	0.663	1.663
1.2	0.023	5.963	0.568	1.768
1.4	0.026	5.111	0.497	1.897

$$* \quad i = \frac{\Delta h}{53}$$

$$** \quad A = \frac{2.7}{20i}$$

*** Solution of the quadratic equation

The minimal value of y_d is taken from the table, which is about 1.6 feet, at a value for Δh of 0.8. The solution, then is that a depth of the filter outlet trench needs only to be about 2 feet to convey the intergranular seepage collected by the filter diaphragm.

The outlet strip drain can be outletted at the toe of the embankment using a cover of riprap and gravel filter to transition from the sand filter to the riprap. Figure 45C-3 shows such a design detail.

A depth of 2 feet for the outlet strip is reasonable, but for a higher embankment permeability where more seepage needs to be conveyed, a gravel zone in the outlet strip may be needed.

Example 1A

The purpose of this example is to illustrate how to evaluate the effect of including a gravel core in the outlet strip drain for a filter diaphragm. This example assumes slightly different values than were used in example 1. Assume that the embankment soils have a permeability of 0.01 foot per day, ten times higher than was assumed for example 1. From steps 1 and 2 in example 1, the area of the filter diaphragm is assumed to be 432 square feet and the hydraulic gradient in the embankment is assumed to be 0.0625.

Step 3 Assume the embankment soils have a permeability equal to 100 times the actual estimated permeability:

$$K = 100 \times K_{emb} = 100 \times 0.01 \text{ ft/d} = 1.0 \text{ ft/d}$$

Step 4 Compute the design Q using Darcy's Law.

$$Q = K \times i \times A$$

$$Q = 1.0 \times 0.0625 \times 432 = 27.0 \text{ ft/d}$$

Step 5 Assume the same dimensions for the coarse drain as was assumed for a fine drain section.

$$A = 3 \times d^2 + 8.8 \times d$$

Now, assume that the gravel to be used in the outlet strip drain has a coefficient of permeability of 2,000 feet per day.

Then, in terms of Q :

$$A = \frac{Q}{K_{filter} \times i} = \frac{27}{2,000 \times i}$$

Step 6 Prepare a table similar to that prepare for example 1 as follows:

Δh , ft	i	A ft ²	d ft	y_d ft
0.50	0.00943	1.4310	0.154	0.404
0.10	0.00189	7.1550	0.663	0.713
0.15	0.00283	4.7700	0.468	0.543
0.20	0.00377	3.5775	0.362	0.462
0.25	0.00472	2.8620	0.295	0.420
0.30	0.00566	2.3850	0.250	0.400
0.35	0.00660	2.0443	0.250	0.425
0.40	0.00755	1.7888	.0215	0.416

The minimum value for y_d from the table is then 0.4 foot, which occurs with a Δh of 0.3 foot. This solution says that the gravel core for the outlet strip needs only to be about 6 inches thick.

A perforated pipe embedded in a gravel section can also be used to further increase the capacity of the strip drain outlet. However, the design shows the gravel zone has adequate capacity without a pipe.

Example 2

Example 2 assumes an embankment cross section as shown on figure 45C-5. The embankment is 23 feet high with 3H:1V slopes upstream and downstream. A filter diaphragm is designed in the embankment that extends upward to 14 feet above grade. A phreatic line constructed from the crest of the normal pool intersects the filter diaphragm at about 10.9 feet above grade. The saturated zone of the embankment is assumed to be subjected temporarily to a surcharge head when the auxiliary spillway flows during a design storm. See figure 45C-5 for other assumed dimensions.

Other assumptions regarding the filter diaphragm are shown in figure 45C-6. The filter diaphragm surrounds a conduit that is 38 inches outside diameter and the conduit lies in an excavation.

The first computation illustrated is the construction of the phreatic line using Casagrande's method. Refer to Soil Mechanics Note 7 for more detail.

Parameters needed to compute the phreatic line are as follows:

- From Soil Mechanics Note 7, m is the distance from the point where the water surface intersects the slope to the toe of the embankment. The horizontal distance is 3 times the vertical depth of water because the slope of the embankment is 3H:1V. Then, m equals $3 \times (488 - 472) = 3(16) = 48$ feet.
- The next computation is to compute $0.3 \times m = 0.3 \times 48 = 14.4$ feet.
- Then from figure 45C-5 and the Soil Mechanics Note 7,

$$d = 0.3m + 21 + 14 + 69 = 118.4 \text{ feet}$$

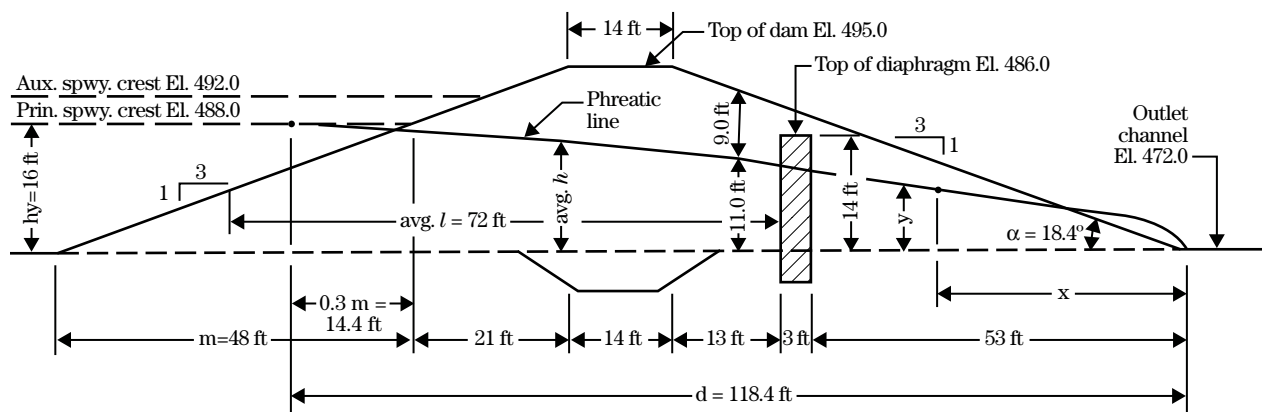
$$h_y = 488.0 - 472.0 = 16.0 \text{ feet}$$

$$y_0 = \sqrt{h_y^2 + d^2} - d$$

$$y_0 = \sqrt{16^2 + 118.4^2} - 118.4$$

$$y_0 = 1.076$$

Figure 45C-5 Structure layout and phreatic line computation



- Compute values of y corresponding to various values of x using the equation:

$$y = \sqrt{2 \times y_0 \times x + y_0^2} = \sqrt{2(1.076x) + 1.158}$$

x	y
10	4.76
20	6.65
40	9.34
56	11.03
70	12.32
100	14.71
120	16.11

The height of the phreatic line where the filter diaphragm intersects it from the table above is then 11.0 feet.

Compute the Design Q for the filter diaphragm from Darcy's Law.

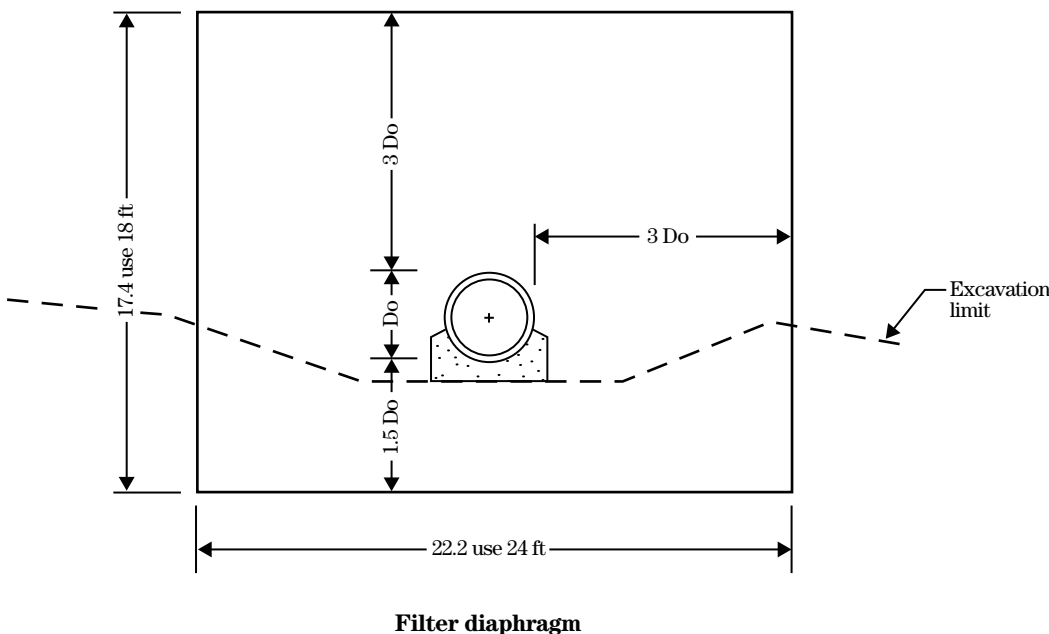
Darcy's Law $Q = K \times i \times A$ is used to compute flow through the embankment:

- The area of embankment contributing flow to the diaphragm is computed. Assume that the height of embankment contributing flow is the average of the height of embankment at the water line, 16 feet and the height of water at the point where the phreatic line intersects the filter diaphragm. The average height is then $(16 + 10.9) \div 2 = 13.5$ feet. The width of the filter diaphragm according to figure 45C-6 is 24 feet.

- So the area of the flow to the diaphragm is

$$A_{fd} = 13.5 \times 24 = 324 \text{ ft}^2$$

Figure 45C-6 Filter diaphragm for example 2



- Compute the hydraulic gradient i , which is equal to Δh divided by Δl . The term Δh is the difference between the auxiliary spillway and the point where the phreatic line intersects the filter diaphragm.

$$\Delta h \text{ is } = 492 - (472 + 11.0) = 9.0 \text{ ft}$$

The term Δl is the length of the flow path from midpoint between the upstream toe of the embankment to the point where the water line intersects the slope to the filter diaphragm.

From figure 45C-5,

$$\Delta l = \frac{16 \times 3}{2} + 21 + 14 + 13 = 72$$

Then,

$$i = \frac{\Delta h}{\Delta l} = \frac{9.0}{72} = 0.125$$

- For conservatism, assume the embankment permeability is 100 times the actual estimated permeability.

$$K = 100 \times K_{\text{emb}} = 100 \times 0.01 = 1.0 \text{ ft/day}$$

- Compute the design Q using Darcy's Law

$$Q = K_{\text{emb}} \times i \times A$$

$$Q = 1.0 \times 0.125 \times 324.0 = 40.5 \text{ ft}^3/\text{day}$$

- Refer to figure 45C-7 for the assumed dimensions of the outlet section that will convey seepage collected by the filter diaphragm to the downstream toe. The initial dimensions of the strip drain are derived as follows. First, assume the height of the drain is the height corresponding to the area calculated by Darcy's Law plus half the hydraulic gradient in the drain. Calculate the average flow area of the drain by Darcy's Law:

$$Q = 40.5 \text{ ft}^3/\text{d} \quad K_r = 20 \text{ ft/d} \quad i = \frac{\Delta h}{\Delta l} = \frac{\Delta h}{53}$$

$$A = \frac{Q}{K_r \times i}$$

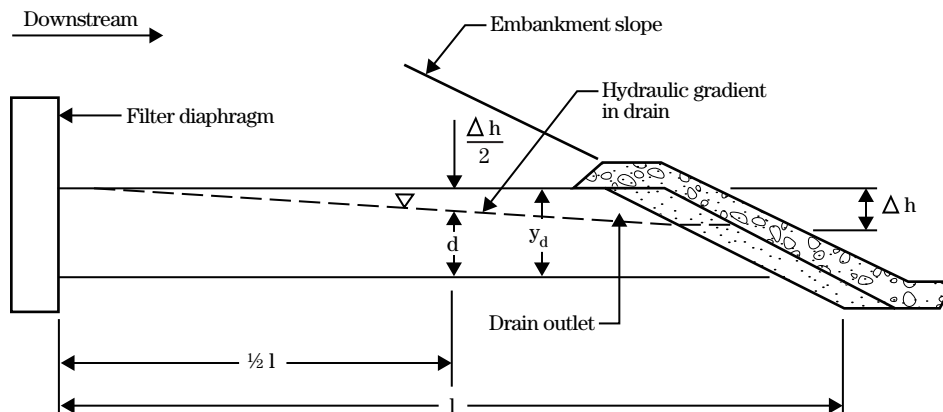
$$A = \frac{40.5}{20 \times i}$$

$$y_d = d + \frac{\Delta h}{2}$$

- Referring to figure 45C-6, the area of the cross section is equal to:

$$A = \frac{1}{2} \times 3d \times d + \frac{1}{2} \times 3d \times d + 8.8d = 3d^2 + 8.8d$$

Figure 45C-7 Filter diaphragm to the downstream toe



Converting to a quadratic equation then:

$$3d^2 + 8.8d - A = 0$$

where $A = \frac{40.7}{20i}$

Assume a range of values for Δh and solve for values of A . Then solve for values of d using a quadratic equation solver. From those values, compute y_d and determine where the minimum y_d occurs, at a value of $\Delta h = 3.8$ feet and $y_d = 3.59$ feet.

Δh , ft	i	A , ft ²	d , ft *	y_d ft **
2.6	0.049	41.279	2.522	3.822
3.0	0.057	35.775	2.285	3.785
3.4	0.064	31.566	2.093	3.793
3.8	0.072	28.243	1.693	3.593
4.0	0.075	26.831	1.864	3.864
4.2	0.079	25.554	1.800	3.900

* d is obtained from solution of quadratic equation using value of A from table.

$$* \quad d = \frac{-8.8 \pm \sqrt{8.8^2 - 4(3)(-A)}}{2(3)}$$

$$** \quad y_d = d + \frac{\Delta h}{2}$$

The area of the strip drain outlet

$$A = 3 \times y_d^2 + 8.8 \times y_d = 3 \times 4^2 + 8.8 \times 4 = 832 \text{ ft}^2$$

This is a reasonable thickness for an outlet strip, but a designer should probably consider employing a coarse filter (gravel) core in the outlet strip drain to provide additional capacity. Computations could be made for that alternative as were made for example 1A.

The outlet strip drain can be outletted at the toe of the embankment using a cover of riprap and gravel filter to transition from the sand filter to the riprap. Figure 45C-4 illustrates an outlet strip drain with a gravel core. Either a geotextile separator should be used between the filter strip and the riprap covering or several intermediate gradation granular filters should be designed using the principles in chapter 26, part 633 of the National Engineering Manual.